

# Neutron oscillations: a window to parallel worlds ?

## *Magnetic anomaly in the UCN storage*

Zurab Berezhiani

Università di L'Aquila and LNGS Gran Sasso, Italy

*LNGS, 2 Feb 2012*

# Content

## ● Content

- Parallel sector
- Carrol's Alice...
- Mirror World
- Twin Particles
- BBN demands
- Interactions
- Interactions
- B & L violation
- See-Saw
- Oscillation
- Neutron mixing
- Neutron mixing
- Oscillation
- Experiment
- Oscillation
- Oscillation
- Vertical B
- Vertical B
- Vertical B
- Vertical B
- Vertical B
- Vertical B
- Neutron mixing
- UHECR
- Spectrum modification
- Auger
- Horizontal B
- Horizontal B
- Epochs
- CMB
- LSS

- Parallel/twin/mirror world (or worlds)
- Interactions and Mixings between ordinary particles and their twins:  
B & L violating mixing
- Neutron - mirror neutron oscillation  $n \rightarrow n'$ :  
B-violation in 1 second ?
- $n - n'$  oscillation and UHECR:  
an earlier end to the cosmic ray spectrum
- Twin matter as dark matter and origin of baryon asymmetries:  
Co-genesis of ordinary and mirror matters via B-L and CP-violating interactions between two sectors
- Cosmology of parallel dark matter:  
implications for the CMB, LSS, galaxy structure, etc.
- Summary:  
consequences for particle phenomenology and cosmology

# Parallel hidden sector vs. observable sector ?

For observable particles .... **very complex physics !!**

Gauge  $G = SU(3) \times SU(2) \times U(1)$  (+ SUSY ? GUT ? RH neutrinos ?)

photon, electron, nucleons (quarks), neutrinos, gluons,  $W^\pm - Z$ , Higgs ...

long range EM forces, confinement scale  $\Lambda_{\text{QCD}}$ , weak scale  $M_W$

... matter vs. antimatter (B-conservation, C/CP ... **Sakharov**)

... existence of nuclei, atoms, molecules .... life.... Homo Sapiens !

**What** if dark matter comes from extra gauge sector ... which is not **ad hoc** simple system but it is **complex** structure alike the observable one?

Parallel gauge sector:  $G' = SU(3)' \times SU(2)' \times U(1)'$  ?

photon', electron', nucleons' (quarks'),  $W' - Z'$ , gluons' ?

... long range EM forces, confinement at  $\Lambda'_{\text{QCD}}$ , weak scale  $M'_W$  ?

... asymmetric dark matter (B'-conservation, C/CP ... ) ?

... existence of twin nuclei, atoms, molecules ... life ... twin Homo Sapiens?

Dark gauge sector ... similar to our particle sector? ... or exactly the same?

.... two (or more) parallel branes in extra dimensions?  $E_8 \times E_8$  ?

**who knows** ..... but let us imagine !

*"Imagination is more important than knowledge..." A. Einstein*

- Content
- Parallel sector
- Carrol's Alice...
- Mirror World
- Twin Particles
- BBN demands
- Interactions
- Interactions
- B & L violation
- See-Saw
- Oscillation
- Neutron mixing
- Neutron mixing
- Oscillation
- Experiment
- Oscillation
- Oscillation
- Vertical B
- Vertical B
- Vertical B
- Vertical B
- Vertical B
- Neutron mixing
- UHECR
- Spectrum modification
- Auger
- Horizontal B
- Horizontal B
- Epochs
- CMB
- LSS

# Alice @ Mirror World

*'Now, if you'll only attend, and not talk so much, I'll tell you all my ideas about Looking-glass House. The room you can see through the glass – that's just the same as our room ... the books there are something like our books, only the words go the wrong way: I know that, because I've held up one of our books to the glass, and then they hold up one in the other room. I can see all of it – all but the bit just behind the fireplace. I do wish I could see that bit! I want so to know whether they've a fire: you never can tell, you know, unless our fire smokes, and then smoke comes up in that room too ... Now we come to the passage: it's very like our passage as far as you can see, only you know it may be quite on beyond. Oh, how nice it would be if we could get through into Looking-glass House! Let's pretend there's a way of getting through into it, somehow... It'll be easy enough to get through I declare!*

*–Alice said this, and in another moment she was through the glass*

Lewis Carroll, "Through the Looking-Glass" (1871)

First clever paper on parallel world



- Content
- Parallel sector
- Carrol's Alice...
- Mirror World
- Twin Particles
- BBN demands
- Interactions
- Interactions
- B & L violation
- See-Saw
- Oscillation
- Neutron mixing
- Neutron mixing
- Oscillation
- Experiment
- Oscillation
- Oscillation
- Vertical B
- Vertical B
- Vertical B
- Vertical B
- Vertical B
- Neutron mixing
- UHECR
- Spectrum modification
- Auger
- Horizontal B
- Horizontal B
- Epochs
- CMB
- LSS

# Following works on “Mirror” World

Parity ( $L \leftrightarrow R$ ) in Weak Ints. restored by Mirror fermions

Lee & Yang '56

“... the books there are like our books, only the words go the wrong way...”

Mirror fermions cannot have our EM & Strong Ints.

Kobzarev et al. '66

hidden sector similar to our but **not exact copy**

Nishijima, Saffouri '64

Mirror matter (invisible stars)

Blinnikov, Khlopov '83

Two SM's:  $SU(3) \times SU(2) \times U(1) \times SU(3)' \times SU(2)' \times U(1)'$

Foot et al. '91

- Two identical gauge factors,  $G \times G'$ , with identical field contents and Lagrangians:  $\mathcal{L}_{\text{tot}} = \mathcal{L} + \mathcal{L}' + \mathcal{L}_{\text{mix}} - SU(5) \times SU(5)', \text{ etc.}$

- Can naturally emerge in string theory: O & M matter fields localized on two parallel branes with gravity propagating in bulk: e.g.  $E_8 \times E_8'$

- Exact parity  $G \leftrightarrow G'$ : Mirror matter is dark (for us), but its particle physics we know exactly (on our skin) – **no new parameters!**

- Asymmetric mirror world: spont. broken parity  $G \leftrightarrow G'$ :

$$\langle \phi' \rangle \gg \langle \phi \rangle \longrightarrow (M'_W \gg M_W)$$

Lepton/quark masses rescale  $\propto M'_W/M_W$ , neutrino masses  $\propto (M'_W/M_W)^2$ ,

but baryon masses  $\propto \Lambda'/\Lambda \sim (M'_W/M_W)^{1/3}$  – *Asymmetric DM, sterile  $\nu$*

*WDM, Strong CP & axidragon, SUSY little Higgs – accidental global  $U(4)$ , etc.*

- Content
- Parallel sector
- Carrol's Alice...
- Mirror World
- Twin Particles
- BBN demands
- Interactions
- Interactions
- B & L violation
- See-Saw
- Oscillation
- Neutron mixing
- Neutron mixing
- Oscillation
- Experiment
- Oscillation
- Oscillation
- Vertical B
- Vertical B
- Vertical B
- Vertical B
- Vertical B
- Neutron mixing
- UHECR
- Spectrum modification
- Auger
- Horizontal B
- Horizontal B
- Epochs
- CMB
- LSS

# Parallel Sector, Twin Particles & Mirror Parity

$SU(3) \times SU(2) \times U(1)$   
gauge ( $g, W, Z, \gamma$ )  
& Higgs ( $\phi$ ) fields

$SU(3)' \times SU(2)' \times U(1)'$   
gauge ( $g', W', Z', \gamma'$ )  
& Higgs ( $\phi'$ ) fields

quarks ( $B=1/3$ )	leptons ( $L=1$ )		quarks ( $B'=1/3$ )	leptons ( $L'=1$ )
$q_L = (u, d)_L^t$	$l_L = (\nu, e)_L^t$		$q'_L = (u', d')_L^t$	$l'_L = (\nu', e')_L^t$
$u_R \quad d_R$	$e_R$		$u'_R \quad d'_R$	$e'_R$
$\widetilde{\text{quarks}} (B=-1/3)$	$\widetilde{\text{leptons}} (L=-1)$		$\widetilde{\text{quarks}} (B'=-1/3)$	$\widetilde{\text{leptons}} (L'=-1)$
$\tilde{q}_R = (\tilde{u}, \tilde{d})_R^t$	$\tilde{l}_R = (\tilde{\nu}, \tilde{e})_R^t$		$\tilde{q}'_R = (\tilde{u}', \tilde{d}')_R^t$	$\tilde{l}'_R = (\tilde{\nu}', \tilde{e}')_R^t$
$\tilde{u}_L \quad \tilde{d}_L$	$\tilde{e}_L$		$\tilde{u}'_L \quad \tilde{d}'_L$	$\tilde{e}'_L$

$$- \mathcal{L}_{\text{Yuk}} = f_L Y \tilde{f}_L \phi + \tilde{f}_R Y^* f_R \tilde{\phi} \quad | \quad \mathcal{L}'_{\text{Yuk}} = f'_L Y' \tilde{f}'_L \phi' + \tilde{f}'_R Y'^* f'_R \tilde{\phi}'$$

- D-parity:  $L \leftrightarrow L', R \leftrightarrow R', \phi \leftrightarrow \phi' : Y' = Y$  • *identical xero copy*
- M-parity:  $L \leftrightarrow R', R \leftrightarrow L', \phi \leftrightarrow \tilde{\phi}' : Y' = Y^\dagger$  • *mirror (chiral) copy*

- Content
- Parallel sector
- Carrol's Alice...
- Mirror World
- **Twin Particles**
- BBN demands
- Interactions
- Interactions
- B & L violation
- See-Saw
- Oscillation
- Neutron mixing
- Neutron mixing
- Oscillation
- Experiment
- Oscillation
- Oscillation
- Vertical B
- Vertical B
- Vertical B
- Vertical B
- Vertical B
- Neutron mixing
- UHECR
- Spectrum modification
- Auger
- Horizontal B
- Horizontal B
- Epochs
- CMB
- LSS

“I want so to know whether they’ve a fire ...” was Alice’s demand meaningful?

Mirror particle physics  $\equiv$  ordinary particle physics

but .... mirror cosmology  $\neq$  ordinary cosmology

- at the BBN epoch,  $T \sim 1 \text{ MeV}$ ,  $g_* = g_*^{SM} = 10.75$   
as contributed by the  $\gamma$ ,  $e^\pm$  and  $3 \nu$  species :  $N_\nu = 3$
  - if  $T' = T$ , mirror world would give the same contribution:  
 $g_*^{\text{eff}} = 2 \times g_*^{SM} = 21.5$  – equivalent to  $\Delta N_\nu = 6.14$  !!!
  - If  $T' < T$ , then  $g_*^{\text{eff}} \approx g_*^{SM} (1 + x^4)$ ,  $x = T'/T \longrightarrow \Delta N_\nu = 6.14 \cdot x^4$   
E.g.  $\Delta N_\nu < 0.4$  requires  $x < 0.5$ ; for  $x = 0.2$   $\Delta N_\nu \simeq 0.01$
  - Paradigm – different initial conditions & weak contact :
    - after inflation  $O$  and  $M$  worlds are (re)heated non-symmetrically,  $T' < T$
    - processes between  $O - M$  particles are slow enough & stay *Out-of-Equilibrium*
    - both sectors evolve *adiabatically*, without significant entropy production

So  $x = T'/T$  is nearly independent of time ( $T'/T = T'_{\text{CMB}}/T_{\text{CMB}}$  today)
- BBN:  $\Delta N_\nu / 6.14 = x^4 \ll 1 \longrightarrow$  BBN':  $\Delta N'_\nu / 6.14 = x^{-4} \gg 1$
- $^1\text{H}$  75%,  $^4\text{He}$  25% vs.  $^1\text{H}'$  25%,  $^4\text{He}'$  75%

Z. Berezhiani, D. Comelli, F. Villante, Phys. Lett. B 503, 362 (2001)

- Content
- Parallel sector
- Carrol's Alice...
- Mirror World
- Twin Particles
- BBN demands
- Interactions
- Interactions
- B & L violation
- See-Saw
- Oscillation
- Neutron mixing
- Neutron mixing
- Oscillation
- Experiment
- Oscillation
- Oscillation
- Vertical B
- Vertical B
- Vertical B
- Vertical B
- Vertical B
- Vertical B
- Neutron mixing
- UHECR
- Spectrum modification
- Auger
- Horizontal B
- Horizontal B
- Epochs
- CMB
- LSS

Possible interactions between  $O$  &  $M$  particles (besides gravity) can be induced at tree level by exchange of extra gauge singlet particles or common gauge fields acting with both  $O$  &  $M$  particles ... and these interactions can lead to particle mixing phenomena between  $O$  &  $M$  sectors: *any neutral particle (elementary or composite) can have mass/kinetic mix its degenerate twin*

■ photon - mirror photon kinetic mixing  $\epsilon F^{\mu\nu} F'_{\mu\nu}$  Holdom '86

mirror particles become "millicharged"  $Q' \sim \epsilon Q$  relative to our photon  $\longrightarrow$

BBN bound  $\epsilon < 3 \times 10^{-8}$ ,

Carlson, Glashow '87

BBN now :  $\epsilon < 2 \times 10^{-9}$ , Structures :  $\epsilon < 3 \times 10^{-10}$  ZB, Lepidi, '08

Natural in GUTs:  $\frac{\alpha}{M_{Pl}^2} (\Sigma G)(\Sigma' G') \rightarrow \epsilon = \alpha s_W^2 \frac{\langle \Sigma \rangle^2}{M_{Pl}^2} < 10^{-8} - 10^{-9}$

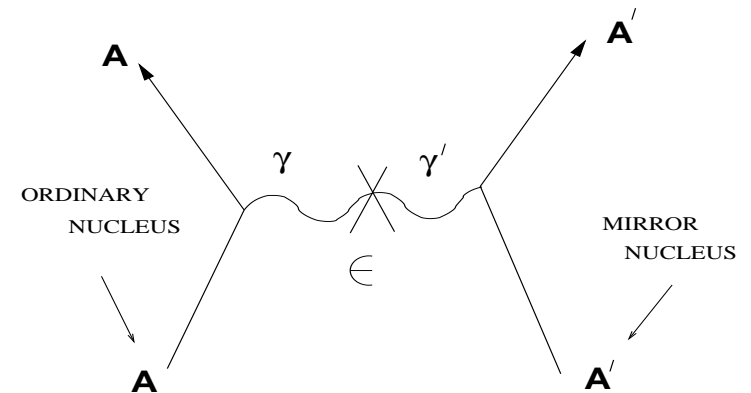

Good for dark matter detection (DAMA) Foot '04

Testable  $O$ -ps -  $O$ -ps' mixing ( $e^+e^- \rightarrow e'^+e'^-$ ) to  $\epsilon \sim 10^{-9}$  Crivelli et al.'10

- Content
- Parallel sector
- Carrol's Alice...
- Mirror World
- Twin Particles
- BBN demands
- Interactions
- Interactions
- B & L violation
- See-Saw
- Oscillation
- Neutron mixing
- Neutron mixing
- Oscillation
- Experiment
- Oscillation
- Oscillation
- Vertical B
- Vertical B
- Vertical B
- Vertical B
- Vertical B
- Neutron mixing
- UHECR
- Spectrum modification
- Auger
- Horizontal B
- Horizontal B
- Epochs
- CMB
- LSS



# meson - mirror meson mixing: $D = 6$ operators

any neutral particle, elementary or composite, can mix its mass degenerate twin

■  $\pi^0 - \pi^{0'}, \quad \rho^0 - \rho^{0'}, \quad \text{etc.}$

$$\frac{1}{M^2} (\bar{u}\gamma^5 u - \bar{d}\gamma^5 d)(\bar{u}'\gamma^5 u' - \bar{d}'\gamma^5 d'),$$

$$\frac{1}{M^2} (\bar{u}\gamma^\mu u - \bar{d}\gamma^\mu d)(\bar{u}'\gamma_\mu u' - \bar{d}'\gamma_\mu d')$$

Phenom. limit:  $M > 10 \text{ TeV}$  ( $\pi^0 - \pi^{0'} \rightarrow 2\gamma'$  invisible)

■  $K^0 - K^{0'} \quad \text{etc.}$

$$\frac{1}{M^2} (\bar{d}\gamma^5 s)(\bar{d}'\gamma^5 s') \quad (\Delta S = 1)$$

C.f.  $\frac{1}{M^2} (\bar{d}\gamma^5 s)(\bar{d}\gamma^5 s) \longrightarrow K^0 - \bar{K}^0$  mixing ( $\Delta S = 2$ )

Phenom. limit:  $M > 100 \text{ TeV}$  ( $K^0 - K^{0'}$ )

● Can be induced via exchange of flavor gauge bosons ( $SU(3)_{\text{fl}}$  etc.) interacting with both our and mirror quarks/leptons : helping for **Flavor Problem**: custodial symmetry, minimality of flavor violation in SUSY (SSB terms alignment), anomaly cancellation for chiral  $SU(3)_{\text{fl}}$ , Vanishing  $D$ -term, etc.

● In the context of TeV scale gravity the gauge flavour bosons can live in extra dimensions (between parallel branes)

- Content
- Parallel sector
- Carrol's Alice...
- Mirror World
- Twin Particles
- BBN demands
- Interactions
- Interactions
- B & L violation
- See-Saw
- Oscillation
- Neutron mixing
- Neutron mixing
- Oscillation
- Experiment
- Oscillation
- Oscillation
- Vertical B
- Vertical B
- Vertical B
- Vertical B
- Vertical B
- Neutron mixing
- UHECR
- Spectrum modification
- Auger
- Horizontal B
- Horizontal B
- Epochs
- CMB
- LSS

# Lepton number violating interactions: $D = 5$ operators

- neutrino - mirror neutrino mixing ( $\nu - \nu'$ ) – effective operators :

Akhmedov, ZB, Senjanovic, 1992; ZB, Mohapatra, 1995

$$\frac{1}{M} (l\phi)(l'\phi') \quad (\Delta L = 1, \Delta L' = 1)$$

C.f.  $\frac{1}{M} (l\phi)^2 \quad (\Delta L = 2), \quad \frac{1}{M} (l'\phi')^2 \quad (\Delta L' = 2)$  for Majorana masses

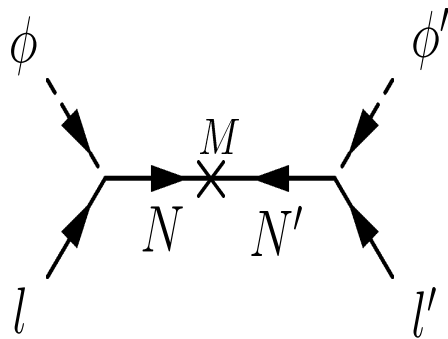

All are generated via "R-handed" neutrinos  $N$   
– extending seesaw mechanism

Inserting VEVs  $\langle \phi \rangle = v$  and  $\langle \phi' \rangle = v'$ ,  
we get  $\nu - \nu'$  (active-sterile) mixing

$$\begin{pmatrix} \hat{m}_\nu & \hat{m}_{\nu\nu'} \\ \hat{m}_{\nu\nu'}^t & \hat{m}_{\nu'} \end{pmatrix} = \begin{pmatrix} \frac{Av^2}{M} & \frac{Dvv'}{M} \\ \frac{D^t vv'}{M} & \frac{A'v'^2}{M} \end{pmatrix} \quad \begin{array}{l} \text{M-parity: } A' = A^*, \quad D = D^\dagger \\ \text{D-parity: } A' = A, \quad D = D^t \end{array}$$

●  $v' = v$ :  $m_{\nu'} = m_\nu$  and maximal mixing  $\theta_{\nu\nu'} = 45^\circ$ ;

●  $v' > v$ :  $m_{\nu'} \sim (v'/v)^2 m_\nu$  and small mixing  $\theta_{\nu\nu'} \sim v/v'$ ;

e.g.  $v'/v \sim 10^2$ :  $\sim \text{keV}$  sterile neutrinos as WDM Z.B., Dolgov, Mohapatra '96

●  $A, A' = 0$  ( $L - L'$  conserved) light Dirac neutrinos

with  $L$  components in ordinary sector and  $R$  components in mirror sector

- Content
- Parallel sector
- Carrol's Alice...
- Mirror World
- Twin Particles
- BBN demands
- Interactions
- Interactions
- B & L violation
- See-Saw
- Oscillation
- Neutron mixing
- Neutron mixing
- Oscillation
- Experiment
- Oscillation
- Oscillation
- Vertical B
- Vertical B
- Vertical B
- Vertical B
- Vertical B
- Vertical B
- Neutron mixing
- UHECR
- Spectrum modification
- Auger
- Horizontal B
- Horizontal B
- Epochs
- CMB
- LSS

# Leptogenesis between $O$ & $M$ sectors

- In the Early Universe, after post-inflationary reheating, these interactions generate also processes like  $l\phi(\tilde{l}\tilde{\phi}) \rightarrow \tilde{l}'\tilde{\phi}'(l'\phi')$  ( $\Delta L = 1$ ) and  $l\phi \rightarrow \tilde{l}\tilde{\phi}$  ( $\Delta L = 2$ ) satisfying **Sakharov's 3 conditions**

**A. violate B-L** – *by definition (only  $L$ )*

**B. violate CP** – *complex Yukawa constants*

**C. out-of-equilibrium** – *already implied by the BBN constraints*

and thus generate  $B-L \neq 0$  ( $\rightarrow B \neq 0$  by sphalerons) for ordinary matter

- The same reactions generate  $B'-L' \neq 0$  ( $\rightarrow B' \neq 0$ ) in dark sector.

Ordinary and mirror Baryon asymmetries can be generated at one shoot !!

**Baryon** & Dark matter Co-genesis

- Content
- Parallel sector
- Carrol's Alice...
- Mirror World
- Twin Particles
- BBN demands
- Interactions
- Interactions
- B & L violation
- See-Saw
- Oscillation
- Neutron mixing
- Neutron mixing
- Oscillation
- Experiment
- Oscillation
- Oscillation
- Vertical B
- Vertical B
- Vertical B
- Vertical B
- Vertical B
- Vertical B
- Neutron mixing
- UHECR
- Spectrum modification
- Auger
- Horizontal B
- Horizontal B
- Epochs
- CMB
- LSS

## Neutron–Mirror-Neutron Oscillations: How Fast Might They Be?

Zurab Berezhiani<sup>1,\*</sup> and Luís Bento<sup>2,†</sup>

<sup>1</sup>*Dipartimento di Fisica, Università di L'Aquila, I-67010 Coppito, AQ, Italy  
and Laboratori Nazionali del Gran Sasso, INFN, I-67010 Assergi, AQ, Italy*

<sup>2</sup>*Faculdade de Ciências, Centro de Física Nuclear da Universidade de Lisboa, Universidade de Lisboa,  
Avenida Professor Gama Pinto 2, 1649-003 Lisboa, Portugal*

(Received 12 August 2005; published 27 February 2006)

We discuss the phenomenological implications of the neutron ( $n$ ) oscillation into the mirror neutron ( $n'$ ), a hypothetical particle exactly degenerate in mass with the neutron but sterile to normal matter. We show that the present experimental data allow a maximal  $n$ - $n'$  oscillation in vacuum with a characteristic time  $\tau$  much shorter than the neutron lifetime, in fact as small as 1 sec. This phenomenon may manifest in neutron disappearance and regeneration experiments perfectly accessible to present experimental capabilities and may also have interesting astrophysical consequences, in particular, for the propagation of ultra high energy cosmic rays.

- Content
- Parallel sector
- Carrol's Alice...
- Mirror World
- Twin Particles
- BBN demands
- Interactions
- Interactions
- B & L violation
- See-Saw
- Oscillation
- Neutron mixing
- Neutron mixing
- Oscillation
- Experiment
- Oscillation
- Oscillation
- Vertical B
- Vertical B
- Vertical B
- Vertical B
- Vertical B
- Vertical B
- Neutron mixing
- UHECR
- Spectrum modification
- Auger
- Horizontal B
- Horizontal B
- Epochs
- CMB
- LSS

# Baryon number violating operators: $D = 9$

any neutral particle, elementary or composite, can mix its mass degenerate twin

- baryon - mirror baryon mixings ( $n - n', \Lambda - \Lambda'$  etc.) ZB, Bento, '05

$$\frac{1}{M^5} (udd)(u'd'd'), \quad \frac{1}{M^5} (qqd)(q'q'd') \quad (\Delta B = 1, \Delta B' = 1)$$

induces he neutron - mirror neutron mass mixing  $\epsilon (\bar{n}n' + \bar{n}'n)$ ,

$$\epsilon \sim \frac{\Lambda_{\text{QCD}}^6}{M^5} \simeq \left(\frac{10 \text{ TeV}}{\mathcal{M}}\right)^5 \cdot 10^{-15} \text{ eV} \quad \mathcal{M} \sim 10 \text{ TeV} \text{ -TeV scale gravity?}$$

- C.f. operators  $\frac{1}{M^5} (udd)^2$  ( $\Delta B = 2$ ),  $\frac{1}{M^5} (u'd'd')^2$  ( $\Delta B' = 2$ )

inducing neutron - antineutron mixing

Kuzmin '70, Glashow '79

Marshak & Mohapatra '80

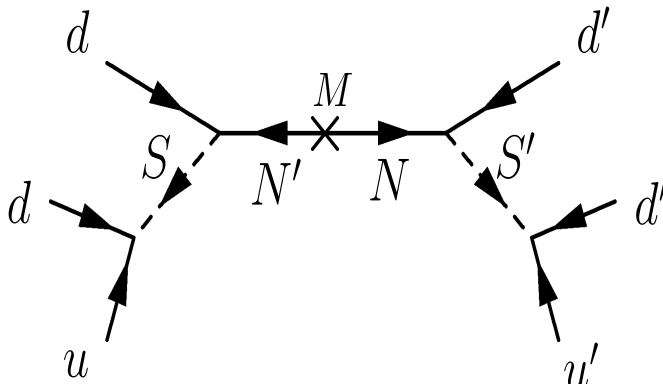

induced by heavy singlet  $N$  "seesaw"  
 $u, d$  and  $u', d'$  ordinary and mirror quarks  
 $S, S'$  color triplet scalars (squarks?)  
 – can generate  $B$  (and  $B'$ ) asymmetry  
 via processes  $dS \rightarrow d'S'$  etc.  
 even below TeV scale (adult Early Universe)

Interesting if  $\mathcal{M} \sim (M_S^4 M_N)^{1/5} \sim 10 \text{ TeV}$

Seesaw:  $M_S, M_N \sim 10 \text{ TeV}$ , or  $M_N \sim 10^{12} \text{ GeV}$  and  $M_S \sim 100 \text{ GeV}$

- Content
- Parallel sector
- Carrol's Alice...
- Mirror World
- Twin Particles
- BBN demands
- Interactions
- Interactions
- B & L violation
- See-Saw
- Oscillation
- Neutron mixing
- Neutron mixing
- Oscillation
- Experiment
- Oscillation
- Oscillation
- Vertical B
- Vertical B
- Vertical B
- Vertical B
- Vertical B
- Neutron mixing
- UHECR
- Spectrum modification
- Auger
- Horizontal B
- Horizontal B
- Epochs
- CMB
- LSS

# Neutron - Mirror neutron mixing

Operators like  $\frac{1}{\mathcal{M}^5}(udd)(u'd'd')$  and  $\frac{1}{\mathcal{M}^5}(qqd)(q'q'd')$

induce  $n - n'$  mixing  $\epsilon(\bar{n}n' + \bar{n}'n)$  with  $\epsilon \sim \left(\frac{10\text{TeV}}{\mathcal{M}}\right)^5 \cdot 10^{-15} \text{ eV}$

•  $n - n'$  oscillation in vacuum: maximal mixing  $\theta = 45^\circ$

and oscillation time  $\tau_{nn'} = \epsilon^{-1} \sim \left(\frac{\mathcal{M}}{10\text{TeV}}\right)^5 \times 1 \text{ s}$

$$P_{nn'}(t) = \sin^2\left(\frac{t}{\tau_{nn'}}\right) \times \exp\left(-\frac{t}{\tau_{\text{dec}}}\right)$$

$n - n'$  allowed to be fast,  $\tau_{nn'} \sim 1\text{ s}$  ... faster than neutron decay !

... similar to neutron - antineutron oscillation but limits on  $n - \bar{n}$  are strong:

Direct experimental Search:  $\tau_{n\bar{n}} > 0.86 \times 10^8 \text{ s}$  Baldo Ceolin et al., '95

Nuclear stability:  $\tau_{n\bar{n}} > 1.3 \times 10^8 \text{ s}$  PDG '2011

## !!! N.B. Nuclear Stability

•  $n - \tilde{n}$  destabilizes nuclei:  $(A, Z) \rightarrow (A - 1, Z, \tilde{n}) \rightarrow (A - 2, Z) + \pi$ 's

$\tau_{n\tilde{n}} > 10^8 \text{ s}$  or so ...

•  $n - n'$  does not:  $(A, Z) \rightarrow (A - 1, Z) + n'$  **forbidden**

for stable nuclei by energy conservation ! – no restriction for  $\tau_{nn'}$  !

- Content
- Parallel sector
- Carrol's Alice...
- Mirror World
- Twin Particles
- BBN demands
- Interactions
- Interactions
- B & L violation
- See-Saw
- Oscillation
- Neutron mixing
- **Neutron mixing**
- Oscillation
- Experiment
- Oscillation
- Oscillation
- Vertical B
- Vertical B
- Vertical B
- Vertical B
- Vertical B
- Vertical B
- Neutron mixing
- UHECR
- Spectrum modification
- Auger
- Horizontal B
- Horizontal B
- Epochs
- CMB
- LSS

# Neutron - Mirror neutron oscillation in external fields

Effective (non-relativistic) Hamiltonian for  $n - n'$  oscillation

$$H = \begin{pmatrix} m - i\Gamma/2 + V + \mu(\vec{B} \cdot \vec{\sigma}) & \epsilon \\ \epsilon & m' - i\Gamma'/2 + V' + \mu'(\vec{B}' \cdot \vec{\sigma}) \end{pmatrix}$$

- Exact mirror parity:  $m' = m, \Gamma' = \Gamma, \mu' = \mu = -1.91\mu_N$
- Grav. potentials are the same:  $V' = V,$
- but there are magnetic fields:  $\vec{B}' \neq \vec{B}$  : at Earth  $B \simeq 0.5 \text{ G}$

Take  $B = (0, 0, B)$  across  $z$ -axis,  $(\sigma B) = B\sigma_z = \text{diag}(B, -B)$  and  $B' = 0$

$$H = \begin{pmatrix} \pm 2\omega & \epsilon \\ \epsilon & 0 \end{pmatrix} \quad \text{diagonal in the basis } (\psi_+, \psi_-, \psi'_+, \psi'_-)$$

*Energy gap*  $2\omega = |\mu B| = B[\text{G}] \times 6 \cdot 10^{-12} \text{ eV} = 9000 \text{ s}^{-1}$

Oscillation probability  $P_{nn'}(t) = \frac{\epsilon^2}{\epsilon^2 + \omega^2} \sin^2(\sqrt{\epsilon^2 + \omega^2} t) \cdot \exp\left(-\frac{t}{\tau_{\text{dec}}}\right)$

$$\omega t \ll 1: P_{nn'}(t) = \left(\frac{t}{\tau_{nn'}}\right)^2, \quad \text{vs.} \quad \omega t \ll 1: P_{nn'}^{\text{av}} = \frac{1}{2(\omega\tau_{nn'})^2}.$$

$$\tau_{nn'} = \epsilon^{-1}$$

- Content
- Parallel sector
- Carrol's Alice...
- Mirror World
- Twin Particles
- BBN demands
- Interactions
- Interactions
- B & L violation
- See-Saw
- Oscillation
- Neutron mixing
- Neutron mixing
- Oscillation
- Experiment
- Oscillation
- Oscillation
- Vertical B
- Vertical B
- Vertical B
- Vertical B
- Vertical B
- Vertical B
- Neutron mixing
- UHECR
- Spectrum modification
- Auger
- Horizontal B
- Horizontal B
- Epochs
- CMB
- LSS

# Experimental & astrophysical bounds

- ILL experiment for  $n - \tilde{n}$  oscillation search in flight:  $t \simeq 0.1$  s,  $B < 10^{-4}$  G
  - no  $\tilde{n}$  event found,  $\tau_{n\tilde{n}} > 0.86 \times 10^8$  s ( $\sim 3$  yr) Baldo Ceolin et al. '94

as for  $n - n'$ : about 5% neutron deficit was observed, so taking

$$P_{nn'}(t) \simeq (t/\tau_{nn'})^2 < 10^{-2}: \quad \tau_{nn'} > 1 \text{ s}$$

- $n - n'$  – anomalous UCN losses,  $\eta < 2 \cdot 10^{-6}$ :  $\tau_{nn'} > 0.2$  s
- Nuclear Stability: no limit for  $\tau_{nn'}$
- BBN bounds and neutron star stability:  $\tau_{nn'} > 10^{-2}$  s

*Recent Experimental search: comparing the neutron losses at small & large B*

- $\tau_{nn'} > 2.7$  s FR Munich, Schmidt et al. Procs. B&L-violation'07, Berkeley
- $\tau_{nn'} > 103$  s ILL Grenoble, Ban et al. Phys.Rev.Lett. 99:161603 (2007) PDG
- $\tau_{nn'} > 414$  s ILL Grenoble, Serebrov et al. Phys.Lett. B663:181 (2008) PDG
- $\tau_{nn'} > 120$  s ILL Grenoble, Altarev et al. Phys.Rev. D 80:032003 (2009) PDG
- $\tau_{nn'} > 403$  s ILL Grenoble, Serebrov et al. NIM A611:137 (2009)

*not valid if masses of  $n$  and  $n'$  states are not **exactly equal**, or gravity is not **quite universal** between  $O$  and  $M$  matters, or there exist non-universal 5th forces of **non-gravitational** origin, or the **mirror magnetic field is non-zero**. **Opposite effect** is possible: magnetic field could **enhance** the oscillation instead of suppressing it.*

- Content
- Parallel sector
- Carrol's Alice...
- Mirror World
- Twin Particles
- BBN demands
- Interactions
- Interactions
- B & L violation
- See-Saw
- Oscillation
- Neutron mixing
- Neutron mixing
- Oscillation
- **Experiment**
- Oscillation
- Oscillation
- Vertical B
- Vertical B
- Vertical B
- Vertical B
- Vertical B
- Neutron mixing
- UHECR
- Spectrum modification
- Auger
- Horizontal B
- Horizontal B
- Epochs
- CMB
- LSS



# $n - n'$ oscillation in mirror magnetic field ( $B' \neq 0$ )

$4 \times 4$  Hamiltonian: oscillations and precessions

ZB, EPJ C64, 421 (2009)

$$H_I = \begin{pmatrix} \mu(\vec{B} \cdot \vec{\sigma}) & \epsilon \\ \epsilon & \mu(\vec{B}' \cdot \vec{\sigma}) \end{pmatrix} = \begin{pmatrix} 2\vec{\omega} \cdot \vec{\sigma} & \epsilon \\ \epsilon & 2\vec{\omega}' \cdot \vec{\sigma} \end{pmatrix}.$$

$$P(t) = \frac{\sin^2[(\omega - \omega')t]}{2\tau^2(\omega - \omega')^2} \cos^2 \frac{\beta}{2} + \frac{\sin^2[(\omega + \omega')t]}{2\tau^2(\omega + \omega')^2} \sin^2 \frac{\beta}{2}, \quad \omega = \frac{\mu B}{2}, \quad \omega' = \frac{\mu B'}{2},$$

$\beta$  angle between  $\vec{B}$  and  $\vec{B}'$ . If  $|\omega - \omega'|t \gg 1$ , oscillations can be averaged,

$$B = 0 : \quad P_0 = \frac{1}{2} \sin^2 2\theta_0 = \frac{\epsilon^2}{2\omega'^2} = 2 \left( \frac{\epsilon}{\mu B'} \right)^2$$

$$B \neq 0 : \quad P(\vec{B}) = \frac{1}{2} \sin^2 2\theta = \frac{1 + \eta^2 + 2\eta \cos \beta}{(1 - \eta^2)^2} P_0, \quad \eta = \frac{B}{B'}$$

$$\frac{P(\vec{B}) + P(-\vec{B})}{2} = P_B = \frac{1 + \eta^2}{(1 - \eta^2)^2} P_0 \quad \text{is independent of } B' \text{ direction } (\cos \beta)$$

$\Delta_B = P_B - P_0$  is **positive** ( $P_B > P_0$ ) if  $\eta < \sqrt{3}$ , i.e.  $B < 1.7B'$

$$\frac{P(\vec{B}) - P(-\vec{B})}{2} = D_B \cos \beta, \quad D_B = \frac{2\eta}{(1 - \eta^2)^2} P_0$$

$D_B \neq 0$  - hint for  $n - n'$  oscillation in the presence of  $B'$

- Content
- Parallel sector
- Carrol's Alice...
- Mirror World
- Twin Particles
- BBN demands
- Interactions
- Interactions
- B & L violation
- See-Saw
- Oscillation
- Neutron mixing
- Neutron mixing
- Oscillation
- Experiment
- **Oscillation**
- Oscillation
- Vertical B
- Vertical B
- Vertical B
- Vertical B
- Vertical B
- Neutron mixing
- UHECR
- Spectrum modification
- Auger
- Horizontal B
- Horizontal B
- Epochs
- CMB
- LSS

# Comparison of observables

- Content
- Parallel sector
- Carrol's Alice...
- Mirror World
- Twin Particles
- BBN demands
- Interactions
- Interactions
- B & L violation
- See-Saw
- Oscillation
- Neutron mixing
- Neutron mixing
- Oscillation
- Experiment
- Oscillation
- Oscillation
- Oscillation
- Vertical B
- Vertical B
- Vertical B
- Vertical B
- Vertical B
- Vertical B
- Neutron mixing
- UHECR
- Spectrum modification
- Auger
- Horizontal B
- Horizontal B
- Epochs
- CMB
- LSS

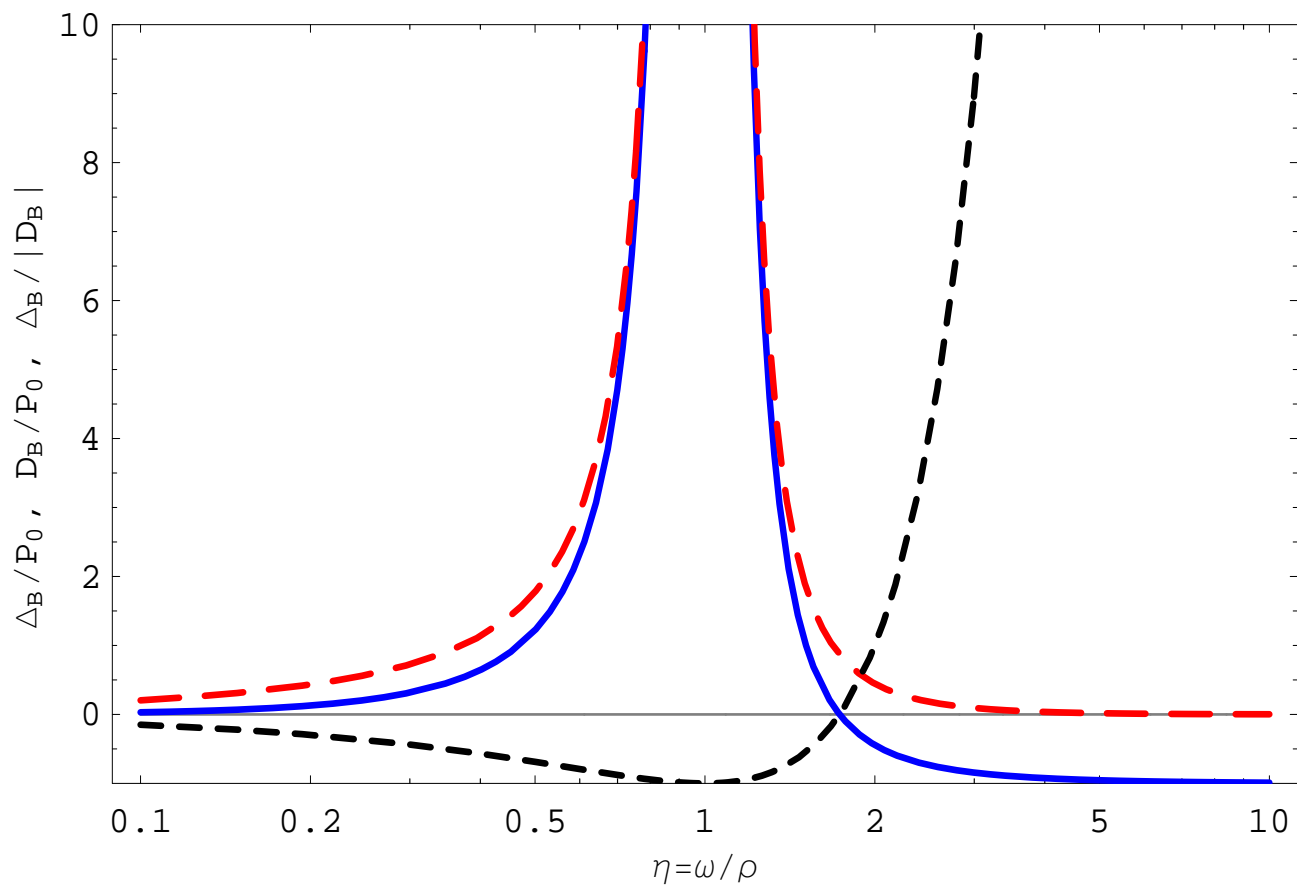

—  $\Delta_B/P_0$   
- -  $D_B/P_0$   
- -  $\Delta_B/D_B$

$\eta = B/B'$

# Experimental strategy for searching $n \rightarrow n'$

Coherent neutron interaction with matter gives "optical" potential  $V \sim \text{few} \times 10^{-7} \text{ eV}$ . Thus, if  $V > 0$ , ultra-cold neutrons (UCN) with  $E_{\text{kin}} < V$ . i.e.  $v < \text{few m/s}$  are reflected from the surface.

Thus, the UCN can be stored in the trap (e.g. beryllium or nickel).  
The material wall of the trap acts as a potential well

If in the trap, during a free flight ( $t_f \sim 0.1 \text{ s}$ ) between the wall collisions  $n$  oscillates to  $n'$ , than it each wall collision it disappears from the trap with a mean probability  $P(\vec{B})$

$$\frac{dN}{dt} = \Gamma_{\text{eff}} N \quad \rightarrow \quad N(t) = N(0) \times e^{-\Gamma_{\text{eff}} t}$$

$$\Gamma_{\text{eff}} = \Gamma_{\text{dec}} + \eta_{\text{loss}} \nu + P(\vec{B}) \nu, \quad \nu = 1/t_f \sim 10 \text{ s}^{-1} \text{ collision frequency.}$$

For different magnetic fields  $\vec{B}_1$  and  $\vec{B}_2$ , all regular ( $B$ -independent) contributions as well as  $N(0)$  cancel out in the ratio  $\frac{N_1(t)}{N_2(t)} = \frac{N(0)e^{-\Gamma_{1\text{eff}}t}}{N(0)e^{-\Gamma_{2\text{eff}}t}} = e^{-(P_1 - P_2)\nu t}$

$$\text{Up down asymmetry } A_B = \frac{N_{\vec{B}} - N_{-\vec{B}}}{N_{\vec{B}} + N_{-\vec{B}}} \approx (D_B \cos \beta) \nu t_s,$$

$$\text{On-off asymmetry } E_{Bb} = \frac{N_{\vec{B}} + N_{-\vec{B}}}{N_{\vec{b}} + N_{-\vec{b}}} - 1 \approx (P_B - P_b) \nu t_s,$$

- Content
- Parallel sector
- Carrol's Alice...
- Mirror World
- Twin Particles
- BBN demands
- Interactions
- Interactions
- B & L violation
- See-Saw
- Oscillation
- Neutron mixing
- Neutron mixing
- Oscillation
- Experiment
- Oscillation
- Oscillation
- Vertical B
- Vertical B
- Vertical B
- Vertical B
- Vertical B
- Neutron mixing
- UHECR
- Spectrum modification
- Auger
- Horizontal B
- Horizontal B
- Epochs
- CMB
- LSS

# Experiment in vertical magnetic field

ILL Grenoble, Serebrov et al. NIM A611:137 (2009)

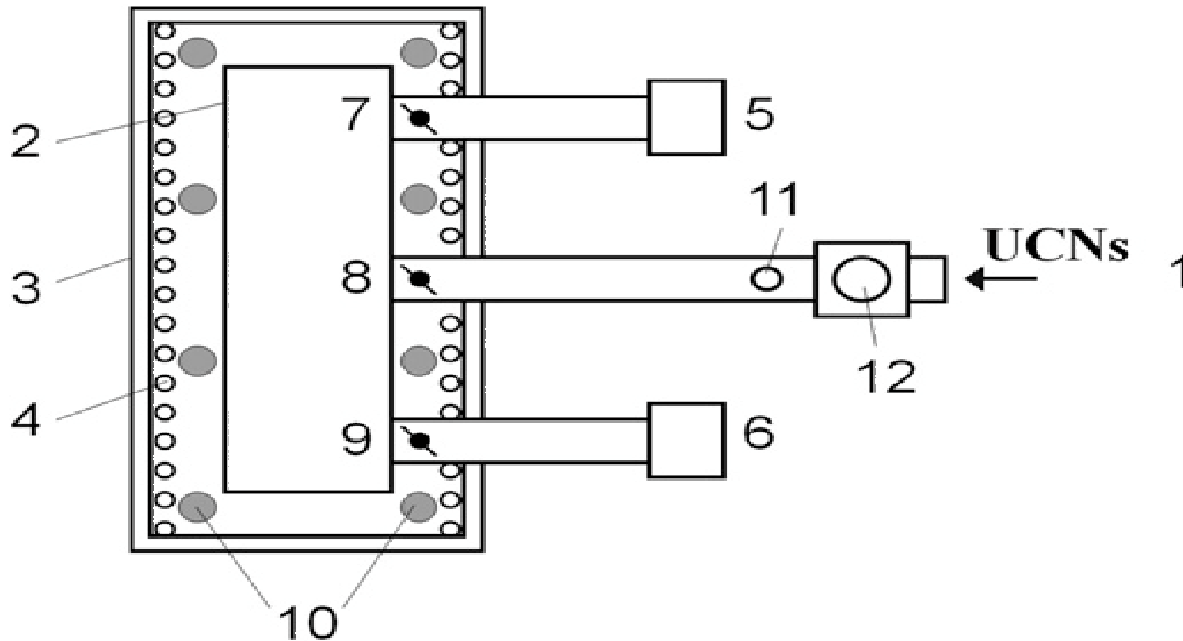

Comparing the losses for different magnetic fields in the UCN trap.], Volume = 190 l, two detectors and monitor in the guide (PF2 EDM).

Up down asymmetry measured  $A = \frac{N_{B+-} - N_{B-}}{N_{B++} + N_{B-}} = (D_B \cos \beta) \nu t_s$ ,

$\nu \approx 11 \text{ s}^{-1}$  collision frequency,  $t_s = 370 \text{ s}$  holding time,  $\nu t_s \approx 4000$

repeating sequence  $B_+, B_-, B_-, B_+$ ;  $B_-, B_+, B_+, B_-$  -  $B \simeq 0.2 \text{ G}$

● - eliminating the linear and quadratic drifts of the neutron flux  $\sim 2\%$

- Content
- Parallel sector
- Carrol's Alice...
- Mirror World
- Twin Particles
- BBN demands
- Interactions
- Interactions
- B & L violation
- See-Saw
- Oscillation
- Neutron mixing
- Neutron mixing
- Oscillation
- Experiment
- Oscillation
- Oscillation
- Oscillation
- Vertical B
- Vertical B
- Vertical B
- Vertical B
- Vertical B
- Neutron mixing
- UHECR
- Spectrum modification
- Auger
- Horizontal B
- Horizontal B
- Epochs
- CMB
- LSS

# Experiment in vertical magnetic field

Z.B. and Nesti, 2011

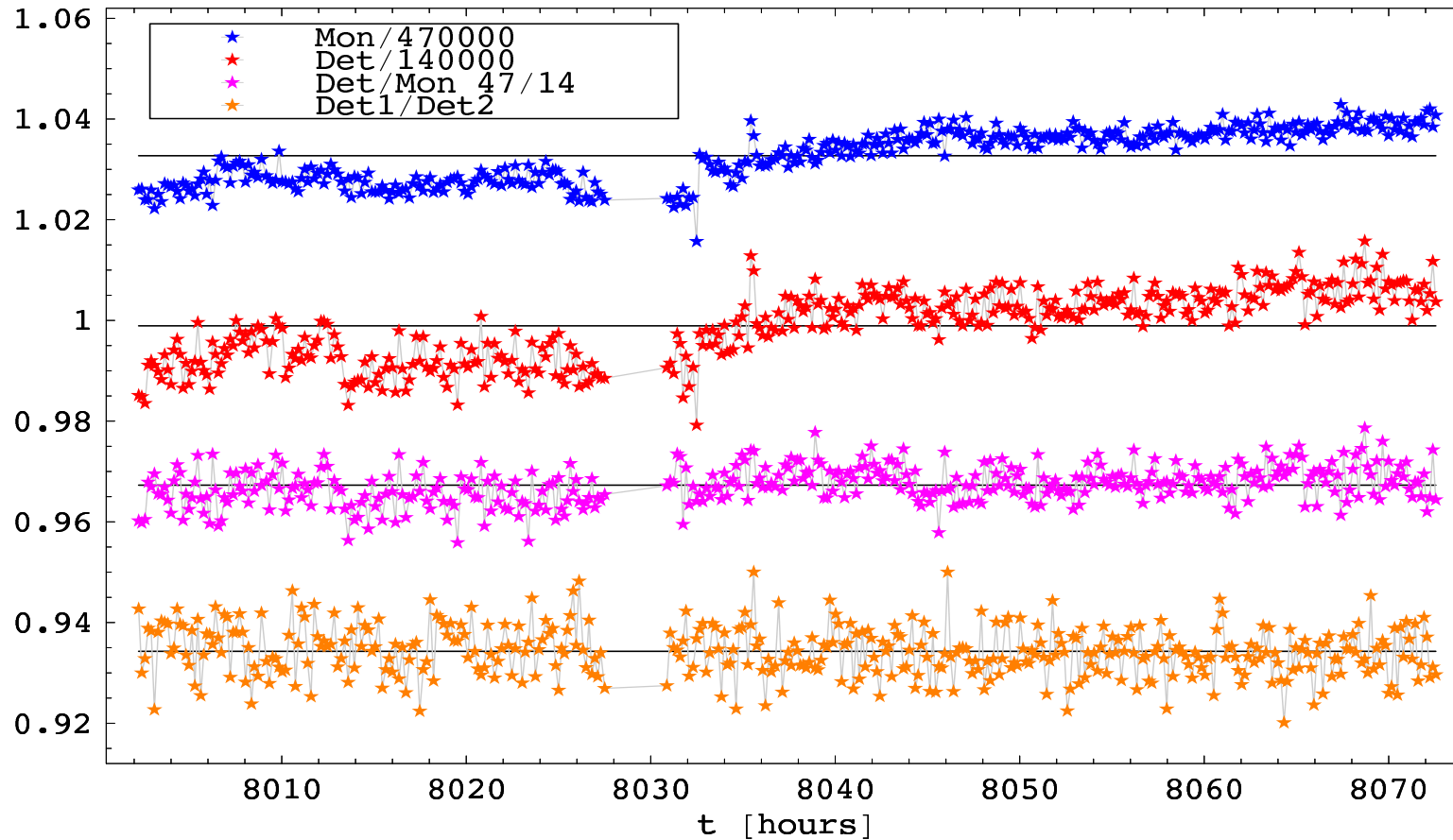

Det/Mon = Const

$$\chi_{\text{dof}}^2 = 1.4$$

Det1/Det2 = Const

$$\chi_{\text{dof}}^2 = 1.0$$

- Content
- Parallel sector
- Carrol's Alice...
- Mirror World
- Twin Particles
- BBN demands
- Interactions
- Interactions
- B & L violation
- See-Saw
- Oscillation
- Neutron mixing
- Neutron mixing
- Oscillation
- Experiment
- Oscillation
- Oscillation
- Vertical B
- Vertical B
- Vertical B
- Neutron mixing
- UHECR
- Spectrum modification
- Auger
- Horizontal B
- Horizontal B
- Epochs
- CMB
- LSS

# Measurements in vertical magnetic field

3 days continuous measurements:  $\sim 400$  data (30 Nov 2007)

$$A = \frac{N_{B+} - N_{B-}}{N_{B+} + N_{B-}} = (D_B \cos \beta) \nu t_s, \quad \text{where } \nu t_s \approx 4000$$

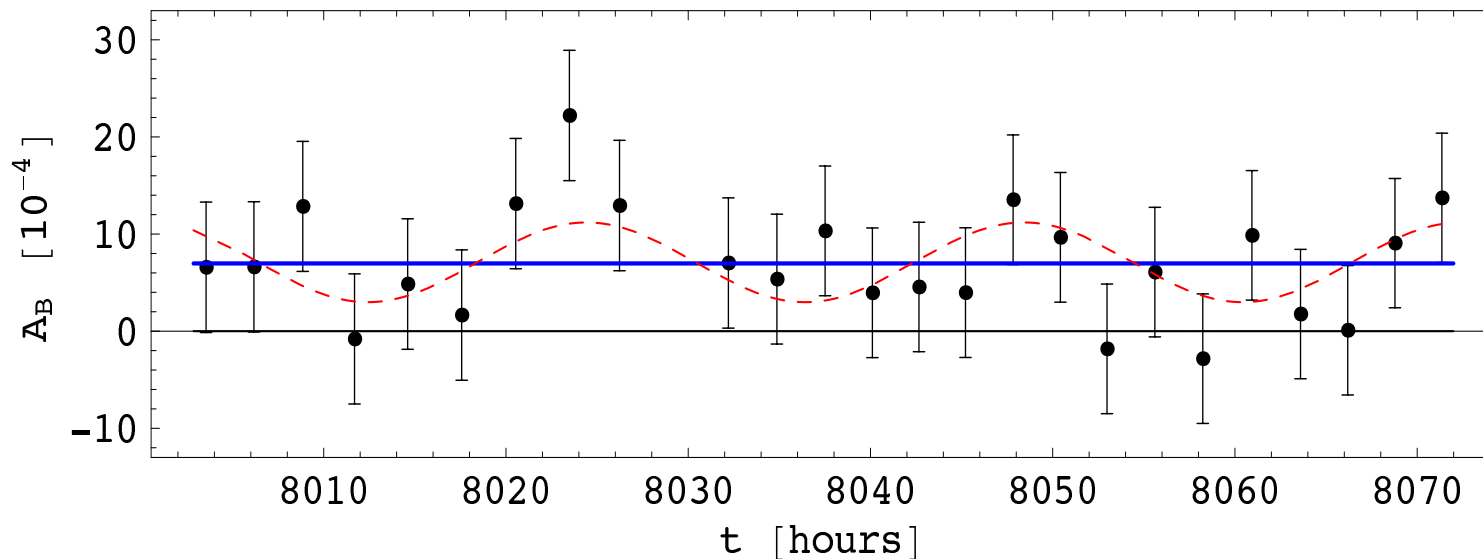

at  $B \simeq 0.2 \text{ G}$  :  $A_B = (7.0 \pm 1.3) \times 10^{-4}$  ( $\chi_{\text{dof}}^2 = 0.9$ ) ( $5.2\sigma$ )

$$[D_B \cos \beta_V] = (1.6 \pm 0.3) \times 10^{-7}$$

– calibration in free flow mode show no evidence for systematic effects

• at  $B \simeq 0.4 \text{ G}$  :  $A_B = (-0.3 \pm 2.4) \times 10^{-4}$  ( $\chi_{\text{dof}}^2 = 1.7$ )

$$[D_B \cos \beta_V] = (-0.06 \pm 0.82) \times 10^{-7}$$

- Content
- Parallel sector
- Carrol's Alice...
- Mirror World
- Twin Particles
- BBN demands
- Interactions
- Interactions
- B & L violation
- See-Saw
- Oscillation
- Neutron mixing
- Neutron mixing
- Oscillation
- Experiment
- Oscillation
- Oscillation
- Vertical B
- Vertical B
- Vertical B
- Vertical B
- Vertical B
- Vertical B
- Neutron mixing
- UHECR
- Spectrum modification
- Auger
- Horizontal B
- Horizontal B
- Epochs
- CMB
- LSS

# Global analysis

Preliminary ...

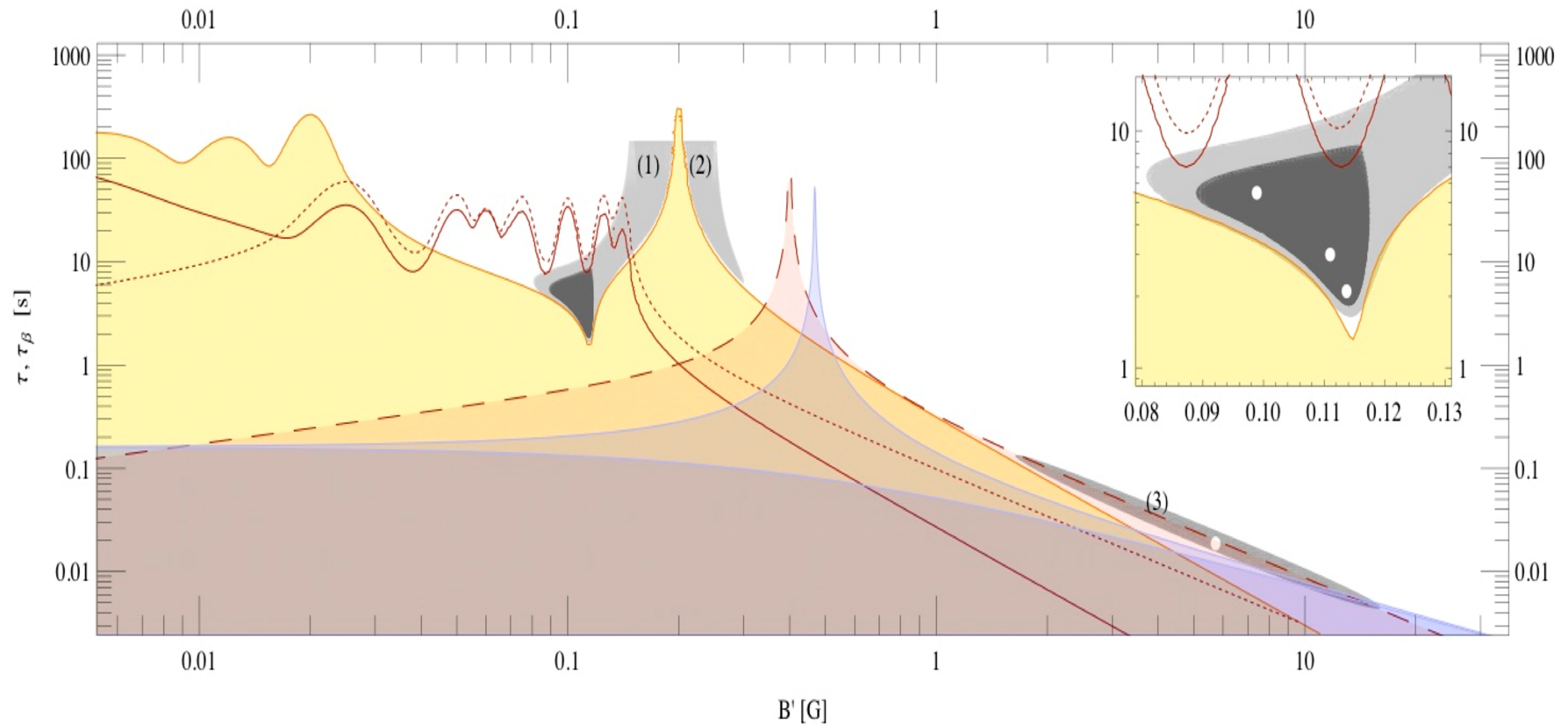

$B' \sim 0.1 \text{ G} , \quad \tau \sim 5 \text{ s} \quad \text{?????}$

Can the Earth possess mirror magnetic field?

.... Why not if mirror matter is dark matter ...

- Content
- Parallel sector
- Carrol's Alice...
- Mirror World
- Twin Particles
- BBN demands
- Interactions
- Interactions
- B & L violation
- See-Saw
- Oscillation
- Neutron mixing
- Neutron mixing
- Oscillation
- Experiment
- Oscillation
- Oscillation
- Oscillation
- Vertical B
- Vertical B
- Vertical B
- Vertical B
- Vertical B
- Vertical B
- Vertical B
- Vertical B
- Vertical B
- Vertical B
- Neutron mixing
- UHECR
- Spectrum modification
- Auger
- Horizontal B
- Horizontal B
- Epochs
- CMB
- LSS

# Neutron - Mirror neutron mixing in astrophysics

● *primordial baryon asymmetry can be generated via  $\Delta B = 1$  processes like  $udd \rightarrow u' d' d'$ . The same (and possibly somewhat larger) baryon asymmetry would be generated in the Mirror sector, which could naturally explain the origin of the baryonic and dark matter balance in the Universe:  $\Omega_D \sim \Omega_B$ .*

**N.B.** *This mechanism does not require that  $n - n'$  oscillation time should be necessarily small, within the present experimental reach. However, it requires collaboration of  $\Delta B = 2$  processes like  $udd \rightarrow \bar{u}\bar{d}\bar{d}$  – (neutron-antineutron oscillation). This should be also active though could be much slower. Hence, should the  $n - n'$  oscillation be detected at the level  $\tau_{nn'} < 10^4$  s, (i.e.  $\mathcal{M}_{nn'} \sim 10$  TeV) it would give a strong argument that  $n - \bar{n}$  oscillation should also exist at the experimentally accessible level, with the relevant cutoff scale  $\mathcal{M}_{n\bar{n}} \sim 100$  TeV and thus  $\tau_{n\bar{n}} \sim 10^9$  s.*

● *If  $\tau_{nn'} < 10^3$  s,  $n - n'$  oscillation provides an elegant mechanism for the transport of the ultra high energy cosmic rays at the large cosmological distances without suffering significant energy depression, and could be of interest in the search of the UHECR spectrum above the GZK cutoff and their correlation with the far distant astrophysical objects (BL Lacs, GRB's etc.)*

● *Effects for the neutrons from the solar flares*

*ZB and Gazizov, ArXiv*

*Mohapatra, Nasri, Nussinov '05*

- Content
- Parallel sector
- Carrol's Alice...
- Mirror World
- Twin Particles
- BBN demands
- Interactions
- Interactions
- B & L violation
- See-Saw
- Oscillation
- Neutron mixing
- Neutron mixing
- Oscillation
- Experiment
- Oscillation
- Oscillation
- Vertical B
- Vertical B
- Vertical B
- Vertical B
- Vertical B
- Neutron mixing
- UHECR
- Spectrum modification
- Auger
- Horizontal B
- Horizontal B
- Epochs
- CMB
- LSS



# $n - n'$ oscillation and propagation of UHECR

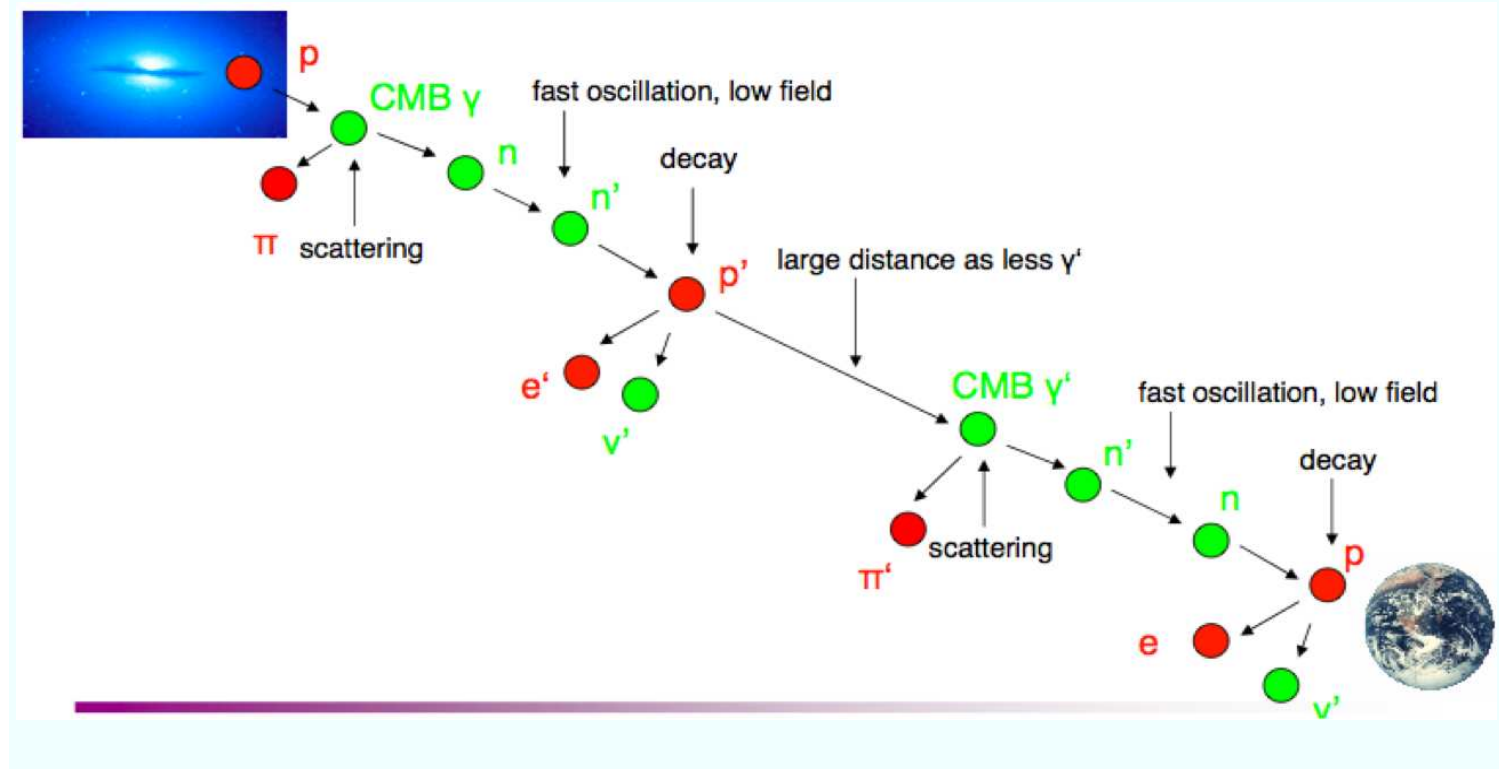

- A.  $p + \gamma \rightarrow p + \pi^0$  or  $p + \gamma \rightarrow n + \pi^+$       $P_{pp,pn} \approx 0.5$       $l_{\text{mfp}} \sim 5 \text{ Mpc}$
- B.  $n \rightarrow n'$       $P_{nn'} \simeq 0.5$       $l_{\text{osc}} \sim 0.1 \text{ Mpc}$
- C.  $n' \rightarrow p' + e' + \bar{\nu}'_e$       $l_{\text{dec}} \sim 1 \text{ Mpc}$
- D.  $p' + \gamma' \rightarrow p' + \pi'^0$  or  $p' + \gamma' \rightarrow n' + \pi'^+$       $l'_{\text{mfp}} \sim (T/T')^3 l_{\text{mfp}} \gg 5 \text{ Mpc}$

- Content
- Parallel sector
- Carrol's Alice...
- Mirror World
- Twin Particles
- BBN demands
- Interactions
- Interactions
- B & L violation
- See-Saw
- Oscillation
- Neutron mixing
- Neutron mixing
- Oscillation
- Experiment
- Oscillation
- Oscillation
- Vertical B
- Vertical B
- Vertical B
- Vertical B
- Vertical B
- Vertical B
- Neutron mixing
- UHECR

- Spectrum modification
- Auger
- Horizontal B
- Horizontal B
- Epochs
- CMB
- LSS

# $n \rightarrow n'$ and modification of UHECR spectrum

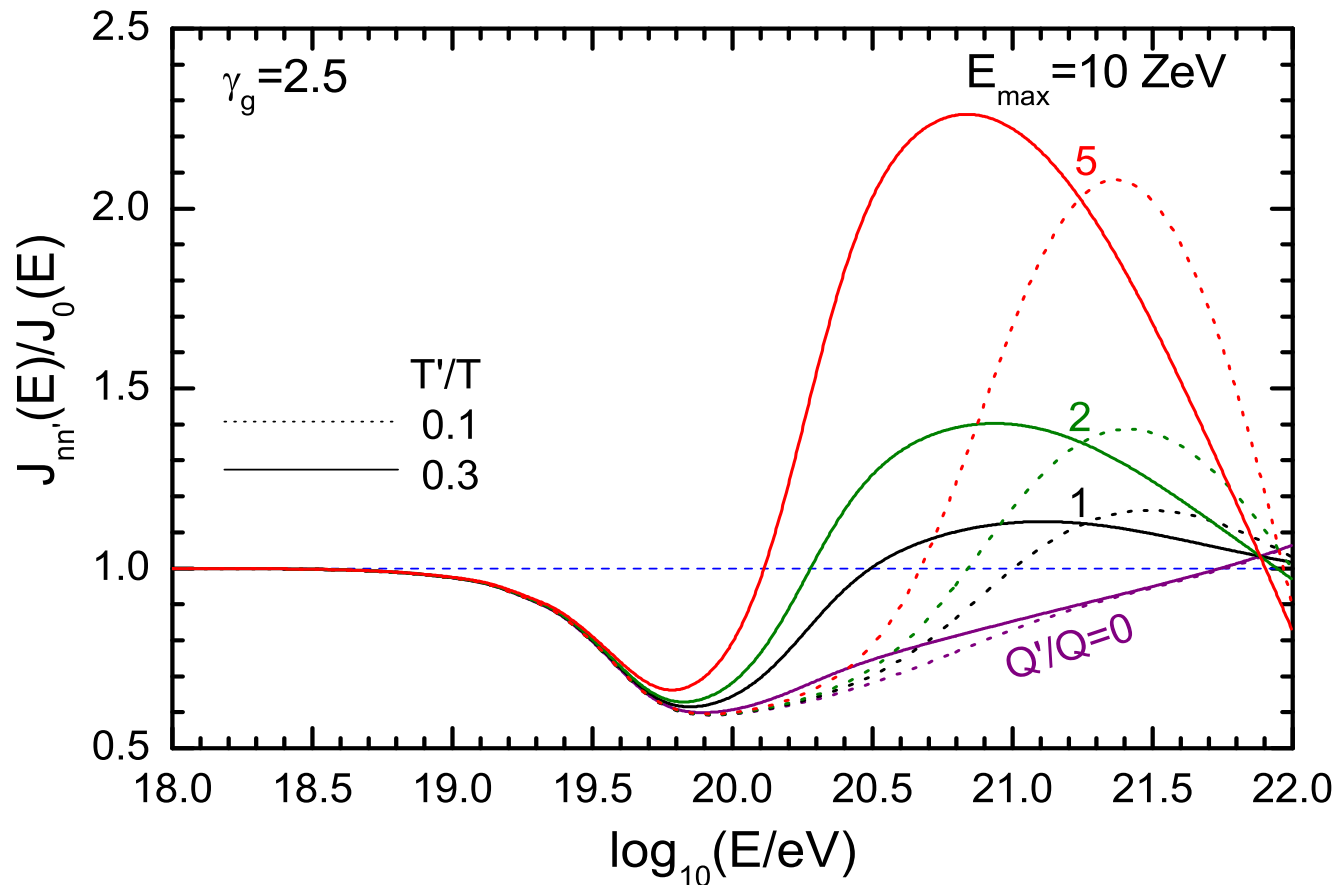

Deformation of UHECR flux relative to the standard GZK prediction

Universal in Energy range  $E = 10 - 100$  EeV

But at energies  $E > 100$  EeV strongly depends on

mirror CMB temperature ( $T'/T < 0.3$ )

and intensity of mirror sources ( $Q'/Q = 0, 1, 2, 5$ )

- Content
- Parallel sector
- Carrol's Alice...
- Mirror World
- Twin Particles
- BBN demands
- Interactions
- Interactions
- B & L violation
- See-Saw
- Oscillation
- Neutron mixing
- Neutron mixing
- Oscillation
- Experiment
- Oscillation
- Oscillation
- Oscillation
- Oscillation
- Vertical B
- Vertical B
- Vertical B
- Vertical B
- Vertical B
- Vertical B
- Neutron mixing
- UHECR
- Spectrum modification
- Auger
- Horizontal B
- Horizontal B
- Epochs
- CMB
- LSS

# Pierre Auger vs HiRes and TA

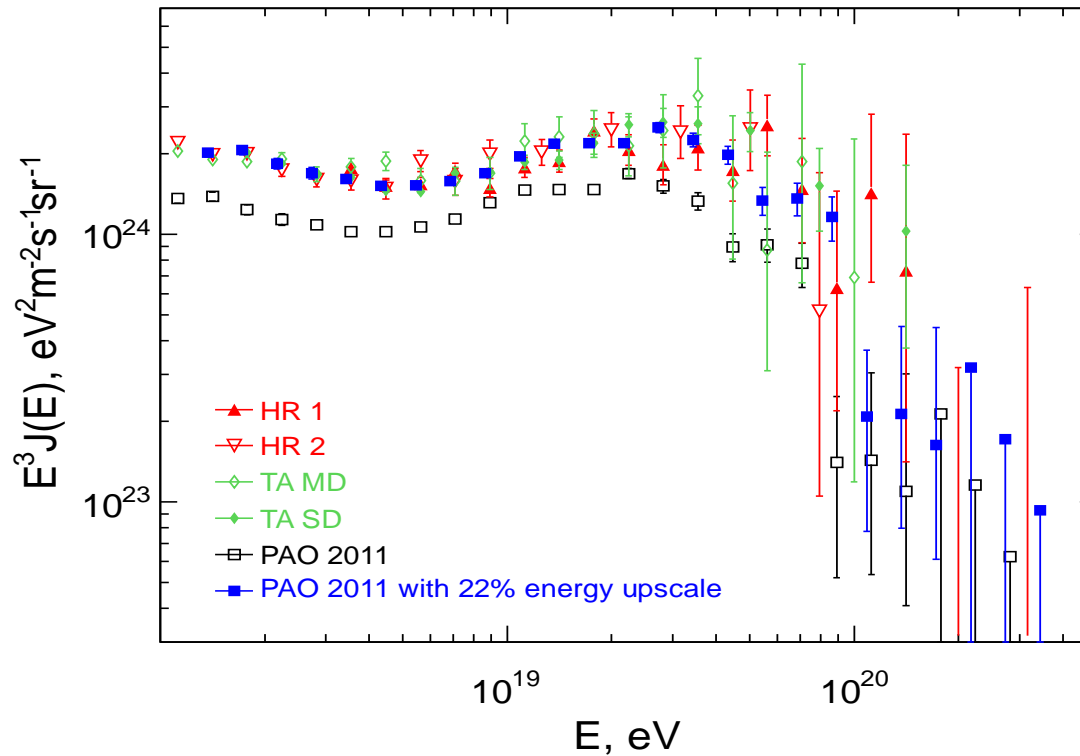

Overall UHECR flux of Auger contradicts to the flux of HiRes and TA  
 is lower by a factor  $\sim 2$   
 as well as to the position of the "dip" due to  $e^+e^-$  production  
 but becomes consistent if Auger energies are upscaled by 20-25%  
 Auger "official" systematic error 22%

- Content
- Parallel sector
- Carrol's Alice...
- Mirror World
- Twin Particles
- BBN demands
- Interactions
- Interactions
- B & L violation
- See-Saw
- Oscillation
- Neutron mixing
- Neutron mixing
- Oscillation
- Experiment
- Oscillation
- Oscillation
- Oscillation
- Vertical B
- Vertical B
- Vertical B
- Vertical B
- Vertical B
- Vertical B
- Neutron mixing
- UHECR
- Spectrum modification
- Auger
- Horizontal B
- Horizontal B
- Epochs
- CMB
- LSS

# Auger data vs GZK cutoff

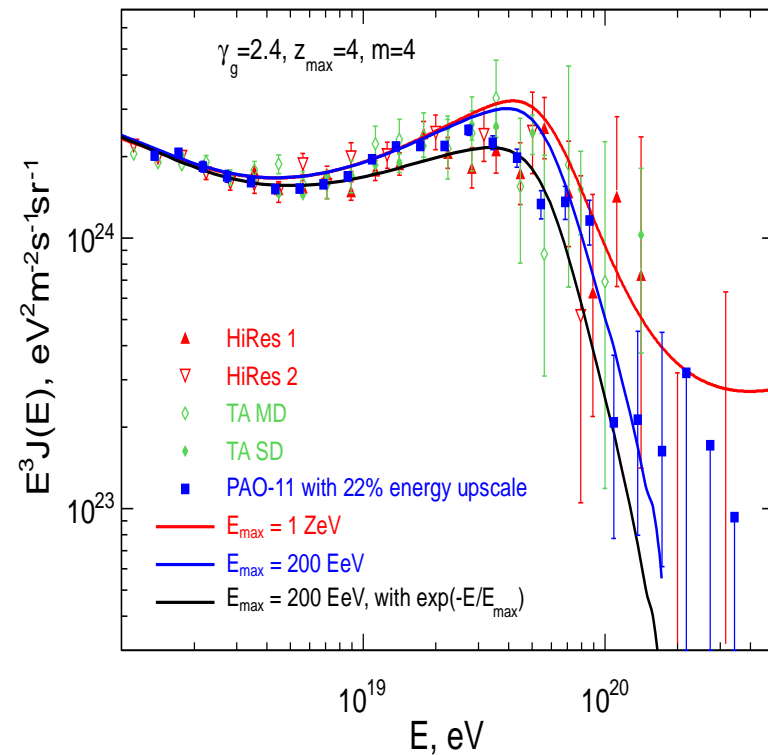
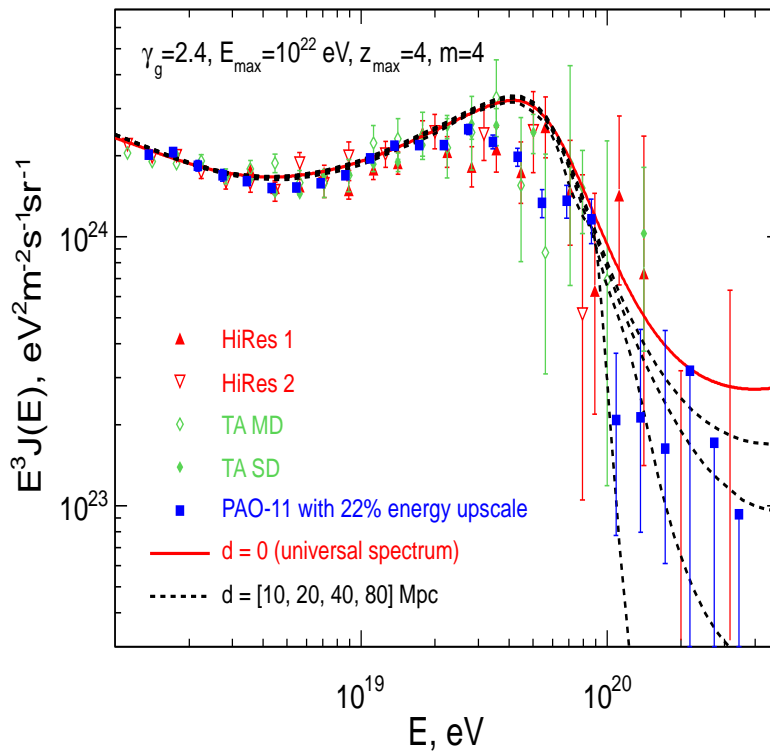

Auger data upscaled by 22% are consistent also to  $e^+e^-$  dip

But indicate **earlier** cutoff of UHECR spectrum than predicted by GZK

$$E_{\text{PAO}}^{\text{cut}} \simeq 30 \text{ EeV vs the GZK prediction } E_{\text{GZK}} \approx \frac{m_{\pi} m_p}{2\varepsilon_{\gamma}} \simeq 60 \text{ EeV}$$

Cannot be explained by increasing the distance to sources (left panel) or by lowering maximal acceleration energy of sources (right panel)

- Content
- Parallel sector
- Carrol's Alice...
- Mirror World
- Twin Particles
- BBN demands
- Interactions
- Interactions
- B & L violation
- See-Saw
- Oscillation
- Neutron mixing
- Neutron mixing
- Oscillation
- Experiment
- Oscillation
- Oscillation
- Oscillation
- Vertical B
- Vertical B
- Vertical B
- Vertical B
- Vertical B
- Vertical B
- Neutron mixing
- UHECR
- Spectrum modification
- Auger
- Horizontal B
- Horizontal B
- Epochs
- CMB
- LSS

# $n - n'$ oscillation and the UHECR spectrum

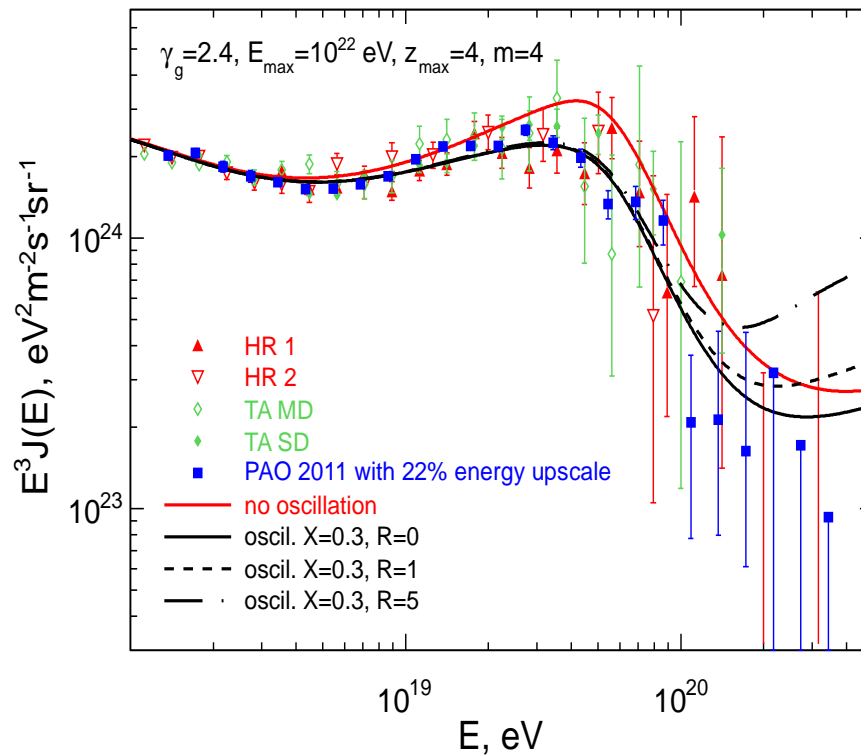

UHECR flux with  $n - n'$  oscillation relative to the standard GZK prediction (normalized to "dip" model) for different intensity of mirror sources:

$$Q'/Q = 0, 1, 5 \quad (T'/T = 0.3)$$

Consistent to **earlier** cutoff of the UHECR spectrum

Waiting next results for cutoff profile (Auger and TA)

Positive predictions for energies at  $E > 100$  EeV (JEM-EUSO)

- Content
- Parallel sector
- Carrol's Alice...
- Mirror World
- Twin Particles
- BBN demands
- Interactions
- Interactions
- B & L violation
- See-Saw
- Oscillation
- Neutron mixing
- Neutron mixing
- Oscillation
- Experiment
- Oscillation
- Oscillation
- Oscillation
- Vertical B
- Vertical B
- Vertical B
- Vertical B
- Vertical B
- Vertical B
- Neutron mixing
- UHECR
- Spectrum modification
- Auger
- Horizontal B
- Horizontal B
- Epochs
- CMB
- LSS

# Mirror Baryons as Dark Matter

As far as Mirror Baryons are dark (in terms of ordinary photons), they could constitute Dark Matter of the Universe [Z.B., Comelli & Villante '01]

- Once  $x < 1$ , mirror photons decouple earlier than our photons:  $z'_{\text{dec}} \simeq \frac{1}{x} z_{\text{dec}}$

However, if the DM is entirely due to mirror baryons, then the large scale structure (LSS) formation requires that mirror photons must decouple before Matter-Radiation Equality epoch:  $x < x_{\text{eq}} = 0.05(\Omega_M h^2)^{-1} \simeq 0.3$

- then mirror Jeans scale  $\lambda'_J$  becomes smaller than the Hubble horizon before Matter-Radiation Equality

- mirror Silk scale is smaller than the one for the normal baryons:

$$\lambda'_S \sim 5x_{\text{eq}}^{5/4} (x/x_{\text{eq}})^{3/2} (\Omega_M h^2)^{-3/4} \text{ Mpc}$$

Hence the structures formation at 1 Mpc scales (galaxies) implies  $x < 0.2$

**N.B.** Since mirror baryons constitute dissipative dark matter, the formation of the extended halos can be problematic, but perhaps possible if the star formation in the mirror sector is rather fast due to different temperature and chemical content (in fact, fast freezeout of BBN in mirror sector is much faster, and it is dominated by Helium).

MACHOs as mirror stars — microlensing:  $M_{\text{av}} = 0.5 M_{\odot}$

- Content
- Parallel sector
- Carrol's Alice...
- Mirror World
- Twin Particles
- BBN demands
- Interactions
- Interactions
- B & L violation
- See-Saw
- Oscillation
- Neutron mixing
- Neutron mixing
- Oscillation
- Experiment
- Oscillation
- Oscillation
- Vertical B
- Vertical B
- Vertical B
- Vertical B
- Vertical B
- Neutron mixing
- UHECR
- Spectrum modification
- Auger
- Horizontal B
- Horizontal B
- Epochs
- CMB
- LSS

# CMB & LSS power spectra

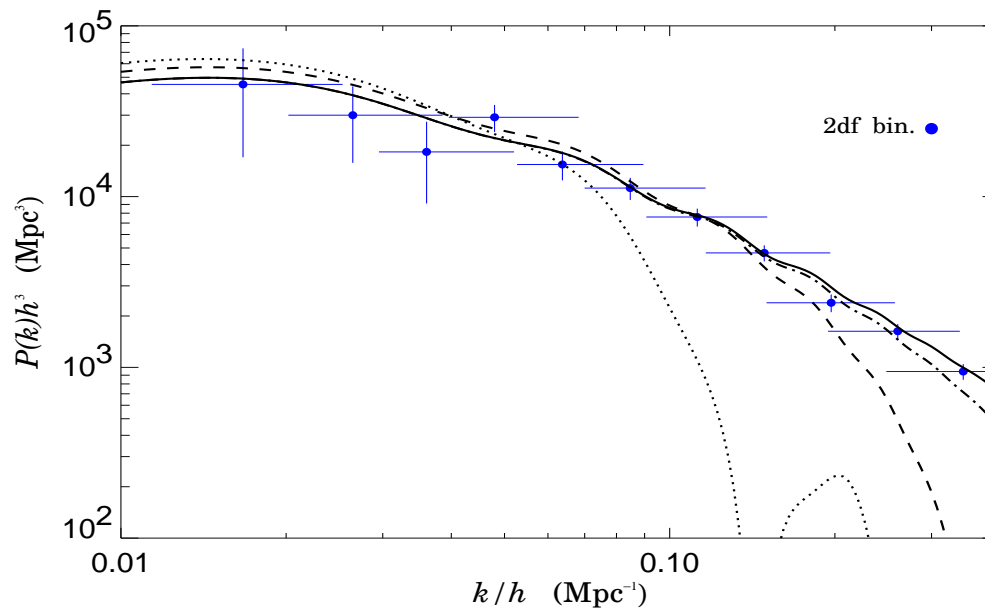
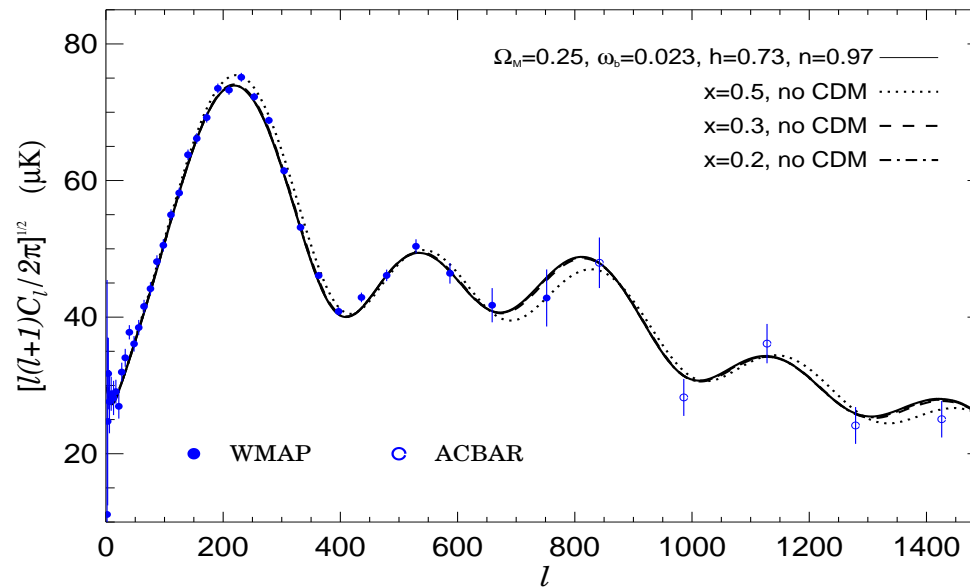

$$x = T'/T < 0.3$$

- Content
- Parallel sector
- Carrol's Alice...
- Mirror World
- Twin Particles
- BBN demands
- Interactions
- Interactions
- B & L violation
- See-Saw
- Oscillation
- Neutron mixing
- Neutron mixing
- Oscillation
- Experiment
- Oscillation
- Oscillation
- Vertical B
- Vertical B
- Vertical B
- Vertical B
- Vertical B
- Vertical B
- Neutron mixing
- UHECR
- Spectrum modification
- Auger
- Horizontal B
- Horizontal B
- Epochs
- CMB
- LSS

# LSS power spectra

Z.B., Ciarcelluti, Comelli & Villante, '03

$$x = T'/T < 0.2 \text{ (0.1?)}$$

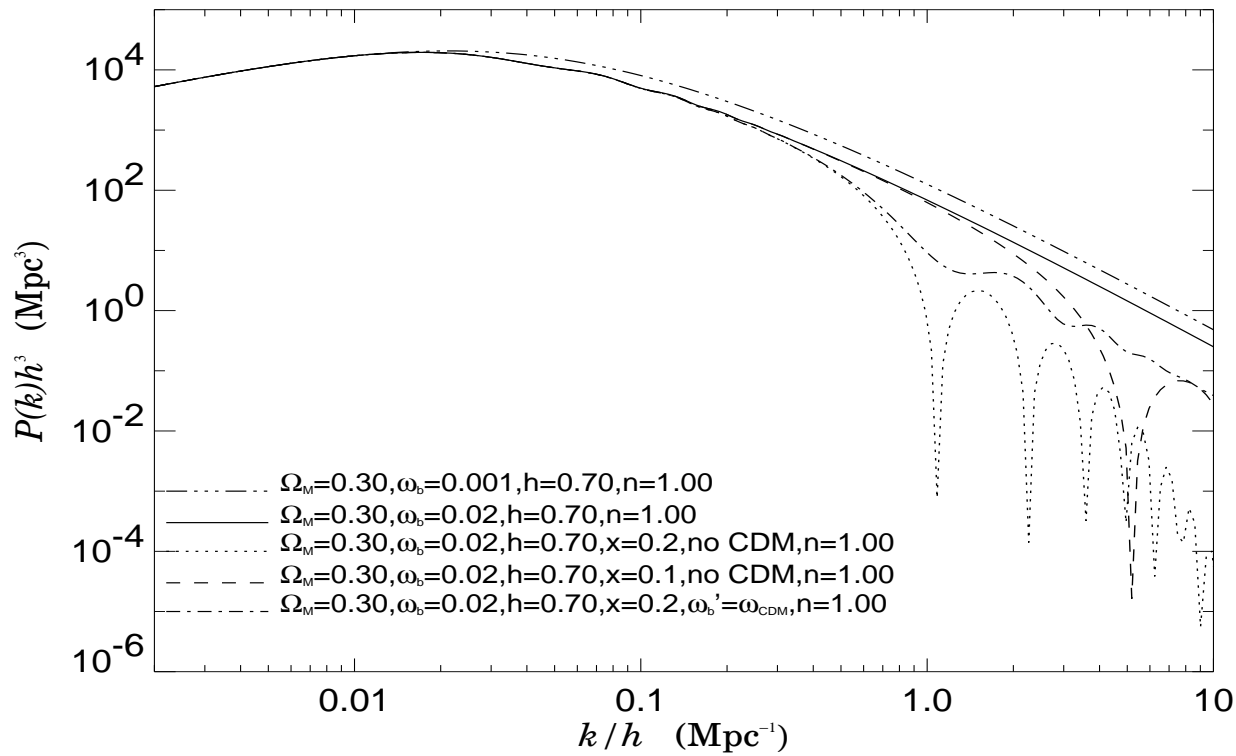

- Content
- Parallel sector
- Carrol's Alice...
- Mirror World
- Twin Particles
- BBN demands
- Interactions
- Interactions
- B & L violation
- See-Saw
- Oscillation
- Neutron mixing
- Neutron mixing
- Oscillation
- Experiment
- Oscillation
- Oscillation
- Vertical B
- Vertical B
- Vertical B
- Vertical B
- Vertical B
- Vertical B
- Neutron mixing
- UHECR
- Spectrum modification
- Auger
- Horizontal B
- Horizontal B
- Epochs
- CMB
- LSS



# Cosmic Coincidence & Fine Tuning Problems

Today's Universe is flat ( $\Omega_{\text{tot}} \approx 1$ ) and multi-component:

- $\Omega_B \simeq 0.04$  observable matter – Baryons !
- $\Omega_D \simeq 0.20$  dark matter: – WIMPS? Axions? ....
- $\Omega_\Lambda \simeq 0.75$  dark energy: –  $\Lambda$ -term? 5th-essence? ....

**A.** coincidence of matter  $\Omega_M = \Omega_D + \Omega_B$  and dark energy  $\Omega_\Lambda$ :  $\Omega_M / \Omega_\Lambda \simeq 0.3$

...  $\rho_\Lambda \sim \text{Const.}$ ,  $\rho_M \sim a^{-3}$ ; **why**  $\rho_M / \rho_\Lambda \sim 1$  – just Today?

Anthropic answer: if not **Today**, then it would happen **Yesterday** or **Tomorrow**.

**B.** Fine Tuning between visible  $\Omega_B$  and dark  $\Omega_D$  matter:  $\Omega_B / \Omega_D \simeq 0.2$

...  $\rho_B \sim a^{-3}$ ,  $\rho_D \sim a^{-3}$ ; **why**  $\rho_B / \rho_D \sim 1$  – **Yesterday Today & Tomorrow?**

– Difficult question ... popular models for primordial Baryogenesis

GUT-B, Lepto-B, Spont. B, Affleck-Dine B, EW B ...

have no feeling for popular DM candidates

Wimp, Wimpzilla, WDM (sterile  $\nu$ ), axion, gravitino ...

– **How Baryon Asymmetry could know about Dark Matter?** – again anthropic

(landscaped) Fine Tunings in Particle Physics and Cosmology? Just for our good?

- Content
- Parallel sector
- Carrol's Alice...
- Mirror World
- Twin Particles
- BBN demands
- Interactions
- Interactions
- B & L violation
- See-Saw
- Oscillation
- Neutron mixing
- Neutron mixing
- Oscillation
- Experiment
- Oscillation
- Oscillation
- Vertical B
- Vertical B
- Vertical B
- Vertical B
- Vertical B
- Neutron mixing
- UHECR
- Spectrum modification
- Auger
- Horizontal B
- Horizontal B
- Epochs
- CMB
- LSS

# Visible vs. Dark matter: $\Omega_D/\Omega_B \simeq 5$ ?

- Visible matter:  $\rho_B = n_B M_B$ ,  $M_B \simeq 1$  GeV – nucleons,  $\eta = n_B/n_\gamma \sim 10^{-9}$

**Sakharov's conditions:**  $B$  ( $B - L$ ) & CP violation, Out-of-Equilibrium

– in Baryogenesis models  $\eta$  depends on several factors, like CP-violating constants, particle degrees of freedom, mass scales, particle interaction strength and goodness of out-of-equilibrium.... and in some models (e.g. Affleck-Dine) on the initial conditions as well ...

- Dark matter:  $\rho_D = n_X M_X$ , but  $M_X = ?$ ,  $n_X = ?$

– too wide spectrum of possibilities ... **Axion:**  $M_X \sim 10^{-5}$  eV, **Sterile  $\nu$**   
**WDM:**  $M_X \sim 1$  keV, **Wimp:**  $M_X \sim 1$  TeV, **Wimpzilla:**  $M_X \sim 10^{14}$  GeV ...

– in relative models  $n_X$  depends on various factors, like equilibrium status and particle degrees of freedom, particle masses and interaction strength (production and annihilation cross sections).... and in some models (e.g. Axion or Wimpzilla) on the initial conditions as well ...

*How then the mechanisms of Baryogenesis and Dark Matter synthesis, having different particle physics and corresponding to different epochs, could know about each-other? – How  $\rho_B = n_B M_B$  could match  $\rho_X = n_X M_X$  so intimately?*

- Content
- Parallel sector
- Carrol's Alice...
- Mirror World
- Twin Particles
- BBN demands
- Interactions
- Interactions
- B & L violation
- See-Saw
- Oscillation
- Neutron mixing
- Neutron mixing
- Oscillation
- Experiment
- Oscillation
- Oscillation
- Vertical B
- Vertical B
- Vertical B
- Vertical B
- Vertical B
- Neutron mixing
- UHECR
- Spectrum modification
- Auger
- Horizontal B
- Horizontal B
- Epochs
- CMB
- LSS

# Cosmological evolution: B vs. D – demonstrating Fine Tuning

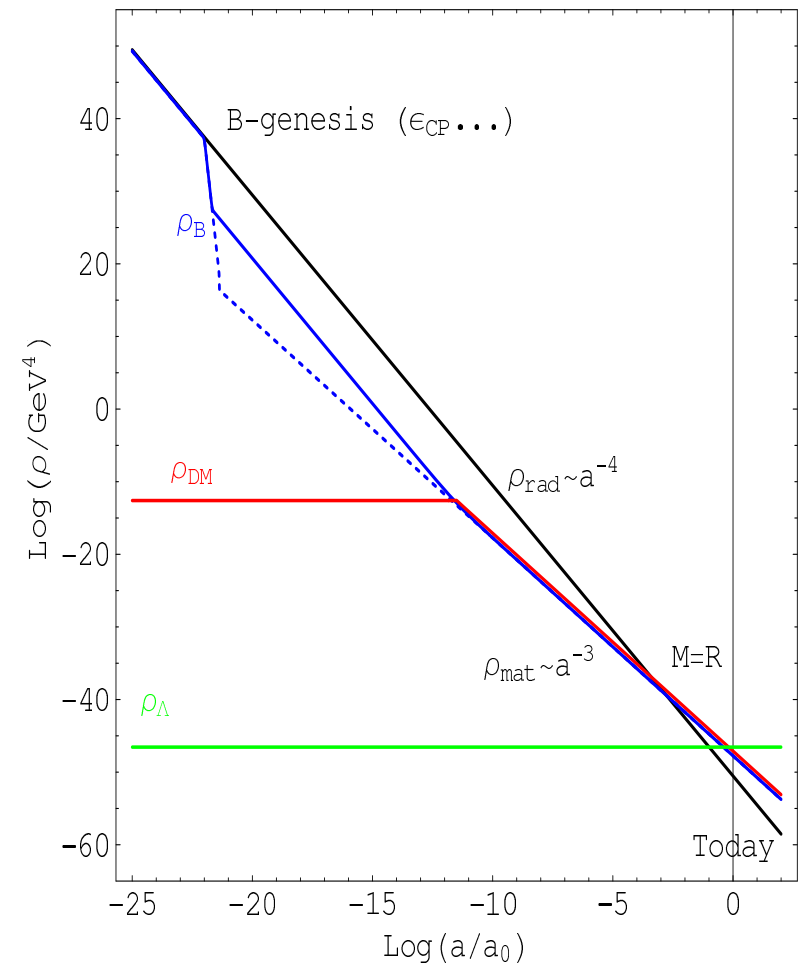
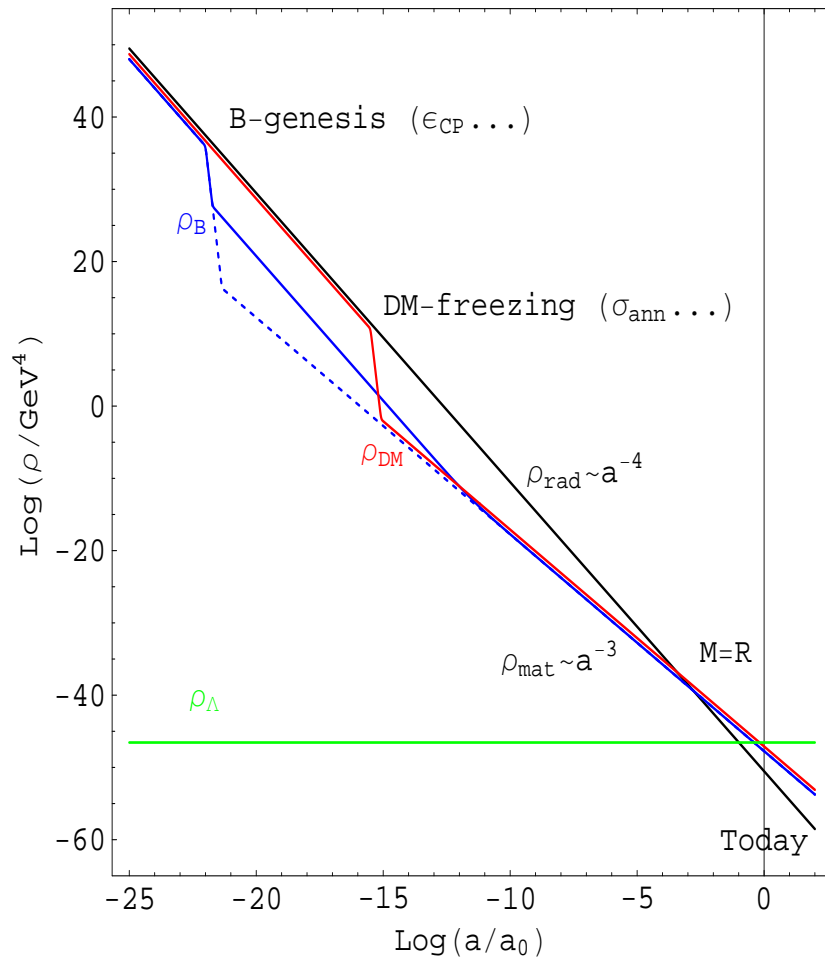

*Evolution of the Baryon number ( ··· ) in e.g. Baryo-Leptogenesis scenario confronted to the evolution of the Dark Matter density ( — ) in the WIMP (left pannel ) and Axion (right pannel) scenarios*

- Content
- Parallel sector
- Carrol's Alice...
- Mirror World
- Twin Particles
- BBN demands
- Interactions
- Interactions
- B & L violation
- See-Saw
- Oscillation
- Neutron mixing
- Neutron mixing
- Oscillation
- Experiment
- Oscillation
- Oscillation
- Vertical B
- Vertical B
- Vertical B
- Vertical B
- Vertical B
- Vertical B
- Neutron mixing
- UHECR
- Spectrum modification
- Auger
- Horizontal B
- Horizontal B
- Epochs
- CMB
- LSS

# Unified origin of B and D? Both fractions at one shoot?

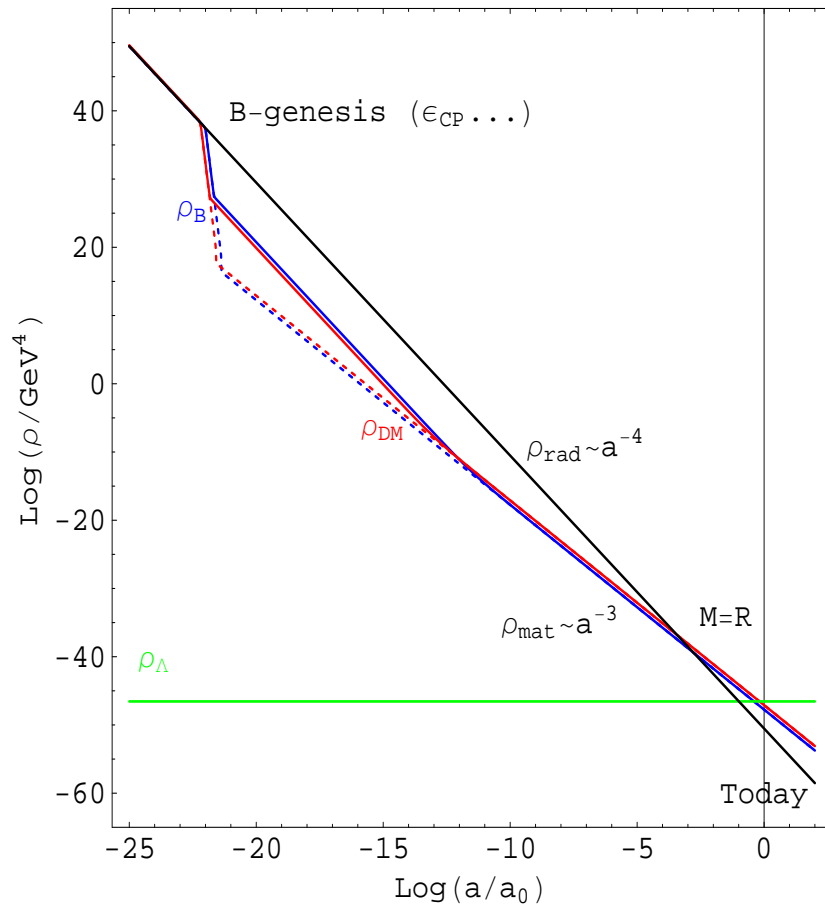

Observable and dark matter co-genesis:  
both based on Baryon asymmetry ?

- Dark particle masses/properties are similar to baryon ones:  $M_X \sim M_B$
- Dark & B asymmetries are generated by one process and  $n_X \sim n_B$

so that  $\frac{\rho_X}{\rho_B} = \frac{M_X n_X}{M_B n_B} \geq 1$  - dark gauge sector with  $B'$  asymmetry

- Content
- Parallel sector
- Carrol's Alice...
- Mirror World
- Twin Particles
- BBN demands
- Interactions
- Interactions
- B & L violation
- See-Saw
- Oscillation
- Neutron mixing
- Neutron mixing
- Oscillation
- Experiment
- Oscillation
- Oscillation
- Vertical B
- Vertical B
- Vertical B
- Vertical B
- Vertical B
- Vertical B
- Neutron mixing
- UHECR
- Spectrum modification
- Auger
- Horizontal B
- Horizontal B
- Epochs
- CMB
- LSS

# CP violation in $\Delta L=1$ and $\Delta L=2$ processes

L. Bento, Z. Berezhiani, PRL 87, 231304 (2001)

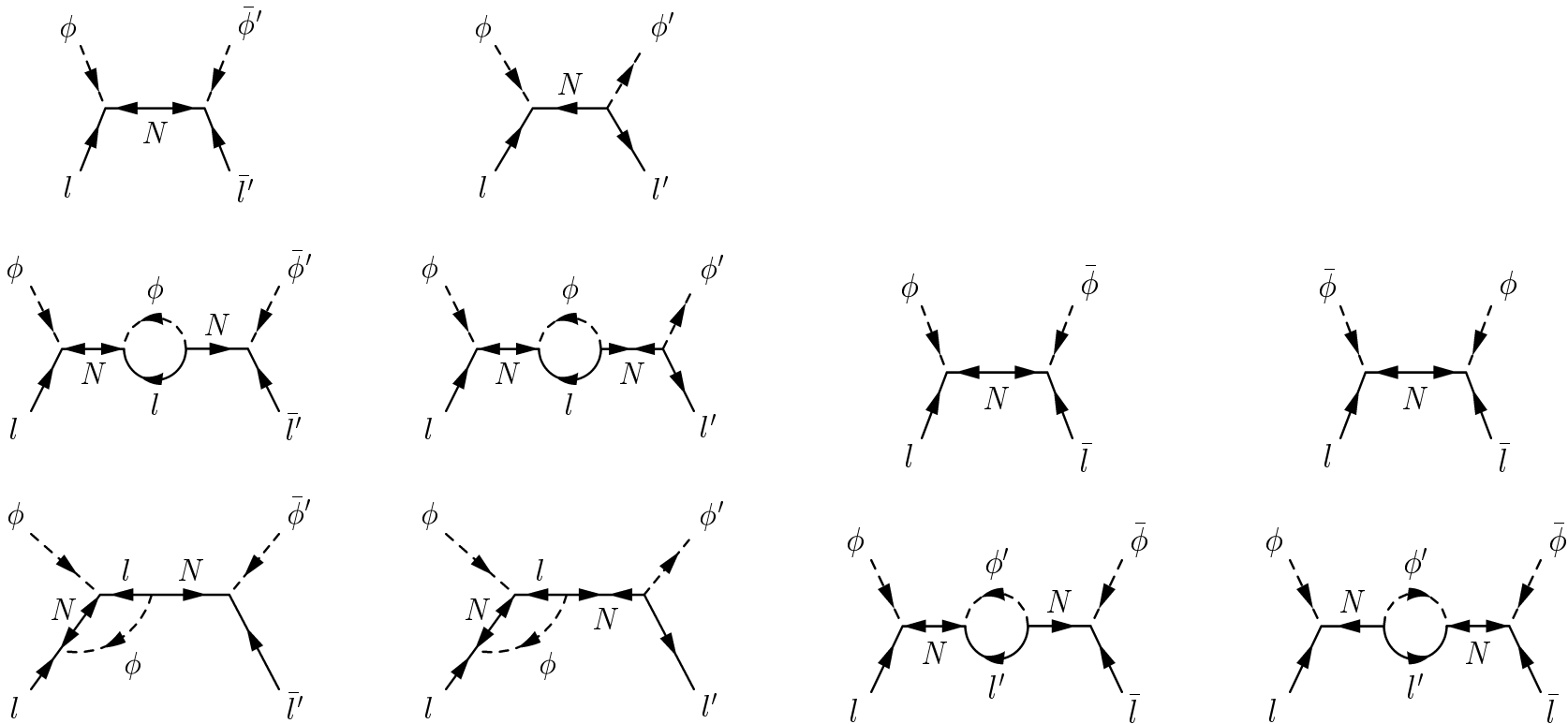

$$\varepsilon_{CP} = \text{Im Tr}[(y^\dagger y)^* g^{-1} (y'^\dagger y') g^{-2} (y^\dagger y) g^{-1}]$$

$$\varepsilon'_{CP} = \text{Im Tr}[(y'^\dagger y')^* g^{-1} (y^\dagger y) g^{-2} (y'^\dagger y') g^{-1}]$$

$$\varepsilon_{CP} \rightarrow \varepsilon'_{CP}$$

$$\text{when } y \rightarrow y'$$

- D-parity:  $y' = y$ ,  $\varepsilon_{CP} = 0$ , but M-parity:  $y' = y^\dagger$   $\varepsilon_{CP} \neq 0$

- Content
- Parallel sector
- Carrol's Alice...
- Mirror World
- Twin Particles
- BBN demands
- Interactions
- Interactions
- B & L violation
- See-Saw
- Oscillation
- Neutron mixing
- Neutron mixing
- Oscillation
- Experiment
- Oscillation
- Oscillation
- Vertical B
- Vertical B
- Vertical B
- Vertical B
- Vertical B
- Vertical B
- Neutron mixing
- UHECR
- Spectrum modification
- Auger
- Horizontal B
- Horizontal B
- Epochs
- CMB
- LSS

## Evolution for (B-L)' and (B-L) $T_R \ll M$

$$\frac{dn_{B-L}}{dt} + 3Hn_{B-L} + \Gamma n_{B-L} = \frac{3}{4} \Delta\sigma n_{\text{eq}}^2$$

$$\frac{dn'_{B-L}}{dt} + 3Hn'_{B-L} + \Gamma' n'_{B-L} = \frac{3}{4} \Delta\sigma' n_{\text{eq}}^2$$

$\Gamma \propto n'_{\text{eq}}/M^2$  is the effective reaction rate of  $\Delta L' = 1$  and  $\Delta L' = 2$  processes

$$\Gamma'/\Gamma \simeq n'_{\text{eq}}/n_{\text{eq}} \simeq x^3 ; \quad x = T'/T$$

$$\Delta\sigma' = -\Delta\sigma = \frac{3\varepsilon_{CP} S}{32\pi^2 M^4}, \quad \text{where } S \sim 16T^2 \text{ is the c.m. energy square}$$

$$Y_{BL} = D(k) \cdot Y_{BL}^{(0)}; \quad Y'_{BL} = D(k') \cdot Y_{BL}^{(0)}$$

*Damping factors  $D(k)$  and  $D(k')$ :*  $k = \left[ \frac{\Gamma_{\text{eff}}}{H} \right]_{T=T_R}, \quad k' = kx^2$

$$Y_{BL}^{(0)} \approx 2 \times 10^{-3} \frac{\varepsilon_{CP} M_{Pl} T_R^3}{g_*^{3/2} M^4}; \quad T_R \text{ is (re)heating temperature}$$

$$Y_{BL}^{(0)} \sim 10^{-9} \quad \text{at } M \sim 10^{12} \text{ GeV, } T_R \sim 10^{12} \text{ GeV, } \varepsilon_{CP} \sim 10^{-3}.$$

- Content
- Parallel sector
- Carrol's Alice...
- Mirror World
- Twin Particles
- BBN demands
- Interactions
- Interactions
- B & L violation
- See-Saw
- Oscillation
- Neutron mixing
- Neutron mixing
- Oscillation
- Experiment
- Oscillation
- Oscillation
- Vertical B
- Vertical B
- Vertical B
- Vertical B
- Vertical B
- Neutron mixing
- UHECR
- Spectrum modification
- Auger
- Horizontal B
- Horizontal B
- Epochs
- CMB
- LSS

$$M'_B = M_B \dots \text{but } n'_B > n_B$$

$$B = D(k) \cdot Y^{(0)}, \quad B' = D(k') \cdot Y^{(0)}; \quad Y^{(0)} \approx \frac{\varepsilon_{CP} M_{Pl} T_R^3}{g_*^{3/2} M^4} \cdot 10^{-3}$$

$$k = \left[ \frac{\Gamma_{\text{eff}}}{H} \right]_{T=T_R}, \quad k' = kx^2, \quad x = \frac{T'}{T} < 0.5 \quad (T_R = T_{\text{Reheat}})$$

$$D(k) < D(k') \approx 1: \quad \text{lower limit } \frac{\Omega'_B}{\Omega_B} = \frac{D(k')}{D(k)} > 1$$

Z.B. '03

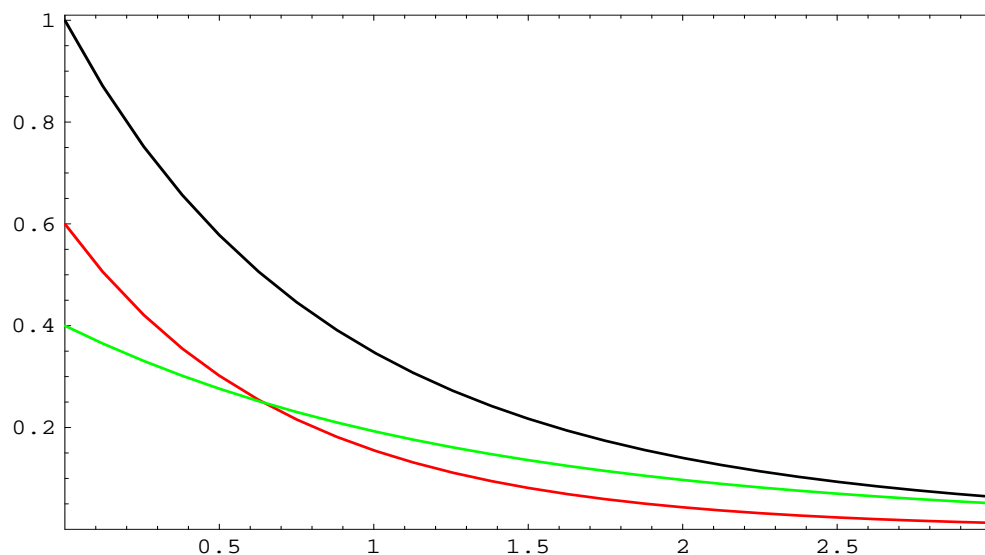

$$\text{BBN: } x < 0.5 \rightarrow k \leq 4; \quad \text{LSS: } x < 0.2 \rightarrow k \leq 1.5$$

$$\text{upper limit } \frac{\Omega'_B}{\Omega_B} = \frac{1}{D(k)} < 5 - 10$$

- Content
- Parallel sector
- Carrol's Alice...
- Mirror World
- Twin Particles
- BBN demands
- Interactions
- Interactions
- B & L violation
- See-Saw
- Oscillation
- Neutron mixing
- Neutron mixing
- Oscillation
- Experiment
- Oscillation
- Oscillation
- Vertical B
- Vertical B
- Vertical B
- Vertical B
- Vertical B
- Vertical B
- Neutron mixing
- UHECR
- Spectrum modification
- Auger
- Horizontal B
- Horizontal B
- Epochs
- CMB
- LSS

## Concluding: “It’ll be easy enough to get through ...”

Parallel (mirror) matter is an attractive candidate for dark matter:

- *Mirror Baryogenesis = dark matter creation:*  $\Omega_{B'} \sim 5\Omega_B$
- *Nucleosynthesis:*  $Y_{He'} > Y_{H'}$
- *Early decoupling:*  $z'_{\text{dec}} > z_{\text{dec}} \simeq 1100$  ... CMB and large scale structures
- *Mirror dark matter in Galaxies: Halo, Machos, dark supernovae, ...*
- *Dark matter search ...*
- *Ordinary particle - mirror particle oscillations: in particular neutron - mirror neutron oscillation – a window to parallel world ?*

"Imagination is more important than knowledge..." A. Einstein

*But knowledge is also important .... so new experiments are welcome:*

- *search for  $n \rightarrow n'$  oscillation and  $n \rightarrow n' \rightarrow n$  regeneration, or  $H \rightarrow H' +$  regeneration for hydrogen*
  - *also  $n \rightarrow \tilde{n}$  or  $\Lambda \rightarrow \tilde{\Lambda}$ ,  $H \rightarrow \tilde{H}$  etc.*
  - *Lorentz-violation in the neutron precession – (corrections to  $\mu$  that resonantly depend on magnetic field value and direction)*
  - *neutrons from solar flares, neutrons in cosmic rays, compact neutron stars, etc*
- **Need for new exps. with bigger statistics and careful systematics**

- Content
- Parallel sector
- Carrol's Alice...
- Mirror World
- Twin Particles
- BBN demands
- Interactions
- Interactions
- B & L violation
- See-Saw
- Oscillation
- Neutron mixing
- Neutron mixing
- Oscillation
- Experiment
- Oscillation
- Oscillation
- Vertical B
- Vertical B
- Vertical B
- Vertical B
- Vertical B
- Vertical B
- Neutron mixing
- UHECR
- Spectrum modification
- Auger
- Horizontal B
- Horizontal B
- Epochs
- CMB
- LSS



## Concluding: *Immediate problems*

● Phenomenological models for  $n - n'$  mixing ("universal see-saw") and relation to  $n - \tilde{n}$  and  $\Lambda - \tilde{\Lambda}$  mixing,  $\pi - \pi'$ ,  $\rho - \rho'$  and  $K - K'$  mixing, *neutrino mixing*  
Physics at  $M \sim$  few TeV – implications for LHC ?

●  $n - n'$  and Baryogenesis: Baryon and Mirror Baryon Asymmetries = ordinary and dark matter co-genesis  $\Omega_{B'} \sim 5\Omega_B$  – at TeV Scale? Relation between  $\eta = n_B/n_\gamma \sim 10^{-9}$  and  $\tau_{nn'}/\tau_{n\tilde{n}} \sim 10^{-8}$  ?

●  $n - n'$  and Nucleosynthesis:  $\Omega_{B'}/\Omega_B \simeq 5$  and  $Y_{He'}/Y_{He} \simeq 3$  –  $N_\nu^{BBN} = 4$  and  $N_\nu^{CMB} = 3$  ?

●  $n - n'$  and Neutron Stars: *very compact objects? Glitches? Neutron star mergers? Anomalous compact objects ? dark supernovae ?*

●  $n - n'$  and Cosmic Rays: *Spectrum of the UHECR, galactic component ...*

● Mirror dark matter in Galaxies: Halo, Machos, dark supernovae, ...  
*Capture of mirror matter by solar system and by the Earth*

● Dark matter search ... *new possibilities regarding DAMA vs. XENON*

● Mirror neutrinos as sterile neutrinos: *neutrino anomalies, BBN bounds*

~ 100 kEuros for new experiments at the ILL (or somewhere else) ?

- Content
- Parallel sector
- Carrol's Alice...
- Mirror World
- Twin Particles
- BBN demands
- Interactions
- Interactions
- B & L violation
- See-Saw
- Oscillation
- Neutron mixing
- Neutron mixing
- Oscillation
- Experiment
- Oscillation
- Oscillation
- Vertical B
- Vertical B
- Vertical B
- Vertical B
- Vertical B
- Neutron mixing
- UHECR
- Spectrum modification
- Auger
- Horizontal B
- Horizontal B
- Epochs
- CMB
- LSS